



COYOTE® 9.5" x 19" (292 mm x 509 mm) Dome Closure

Be sure to read and completely understand this procedure before applying product. Be sure to select the proper PREFORMED product before application.



NOMENCLATURE

- 1. Dome Cover (1)
- 2. Organizer Assembly with End Plate (1)
- 3. Dome Collar (1)
- 4. Gasket (1)
- 5. Grommet (4)
- 6. Small Parts Bag (4)

TOOLS REQUIRED:

- 3/8" and 7/16" can wrench or socket
- Snips
- Fiber optic cable opening tools

| COYOTE® Grommet Chart | | | |
|--|--|-----------------|--------------------|
| For use in COYOTE GLC, Aerial, LCC, Dome, In-Line RUNT, Taut & Terminal Closures | | | |
| PLP Catalog Number | Cable Range Inches (mm) | Description | Splitting Location |
| 8003691 | .42 - .60 (11 - 15 mm) | 1-entry grommet | |
| 8003692 | .60 - .85 (15 - 22 mm) | 1-entry grommet | |
| 8003693 | .85 - 1.0 (22 - 25 mm) | 1-entry grommet | |
| 8003694 | 1.0 - 1.25 (25 - 32 mm) | 1-entry grommet | |
| 8003663 | .42 - .60 (11 - 15 mm) | 2-entry grommet | |
| 8003664 | .30 - .43 (8 - 11mm) | 4-entry grommet | |
| 8003990 | .50 - .60 (12.7 - 15.2) .125 - .25 (3.2 - 6.4) and flat drop | 4-entry grommet | |
| 8003989 | Flat Drop Only | 4-entry grommet | |
| 8003665 | .125 - .25 (3 - 6 mm) | 6-entry grommet | |
| 8003676 | .42 - .60 (11 - 15 mm) .125 - .25 (3 - 6 mm) | 7-entry grommet | |
| 8003677 | .125 - .25 (3 - 6 mm) | 8-entry grommet | |

NOTE: Grommet Kit contains (1) Grommet, (1) Cable Measure Tape, (2) Silicone Lubricant Packs, (1) Set of Plugs and (1) Glove

**Splice Tray/Closure Capacities for
COYOTE® 9.5" x 19" (292 mm x 509 mm) Dome Closure**

| Splice Tray | Catalog Number | Splice Type | Trays per Closure | | Closure Splice Capacity | |
|---------------------------------------|----------------|-----------------------------|-------------------|----------------|-------------------------|----------------|
| | | | Buffer Tube | Unitube/Ribbon | Buffer Tube | Unitube/Ribbon |
| Short Low Profile LITE-GRIP® (12 ct) | 80809958 | Single Fusion | 12 | 11 | 288 | 264 |
| Short Deep Profile LITE-GRIP (40 ct) | 80808945 | Single Fusion or Mechanical | 6 | 5 | 240 | 200 |
| Short Deep Profile LITE-GRIP (144 ct) | LGSTR144 | Mass Fusion/ Ribbon | N/A | 5 | N/A | 720 |

END PLATE PREPARATION

Step #1 Remove end plate from organizer.

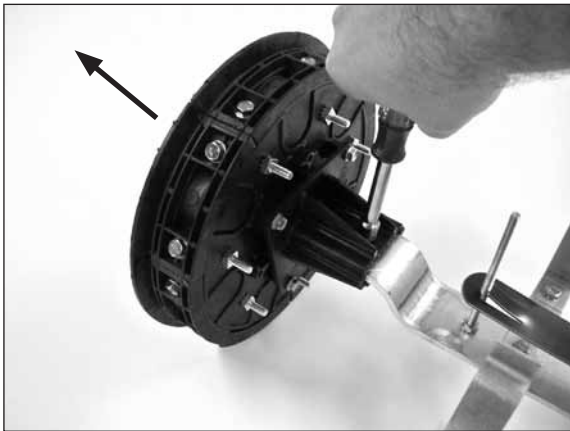

Step #2 Determine which cable ports will be used and mark the respective breakout tabs of end plate.

NOTE: For expressed buffer tubes routed in bottom storage brackets, use cable ports 4 & 5. For expressed buffer tubes routed in side storage brackets and expressed unitube/ribbon cables, use cable ports 3 & 6.



Step #3 Remove the end plate caps from the selected cable ports and break out the tabs.

PLP Tip: Scoring edges of tabs with knife, makes them break out easier.

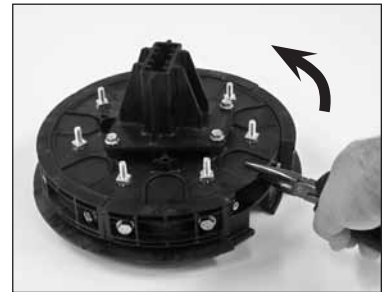

CABLE PREPARATION

Step #4 Measure cable to determine diameter and hole location to use in grommet.



Step #5 If using cut cable, insert cable through grommet. If your application requires express/balloon/ring cut cables, **see Step 7 for grommet slitting procedure.**

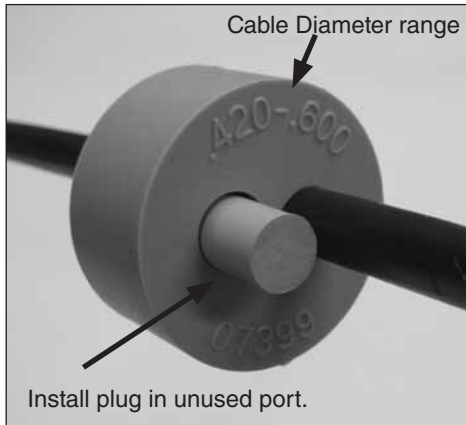

Step #7 Grommet Slitting – If slitting is required, lay grommet on a stable flat surface. Position utility knife with the cutting edge against the top surface and cut through grommet. **Consult grommet chart on page 1, for slitting locations of all grommets.**

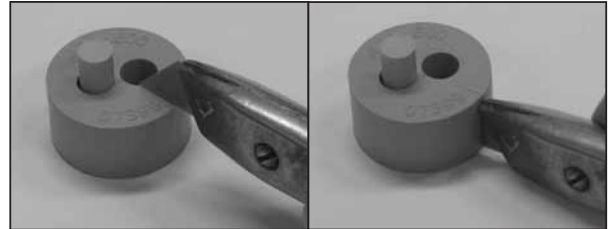

PLP Tip: Use a pen to sketch slitting lines on top surface of grommet prior to cutting.

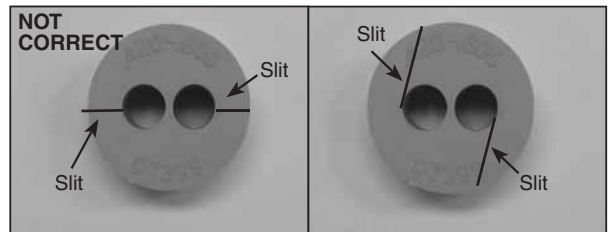

Not Correct Slitting Angle

Correct Slitting Angle

Step #6 Installing Figure 8 Style Cables and Cables with Tracer Wires - Remove tracer wire or ground wire from the portion of the cable that will be positioned in the grommet and insert cable into grommet.

Cable with Tracer Wire

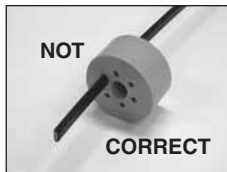

Not Correct Installation



Correct Installation

Figure 8 Style Cable

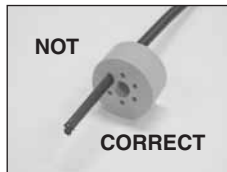

Not Correct Installation



Correct Installation

Step #8 Prepare loose tube/buffer tube or unitube/ribbon cable(s) for cut applications.

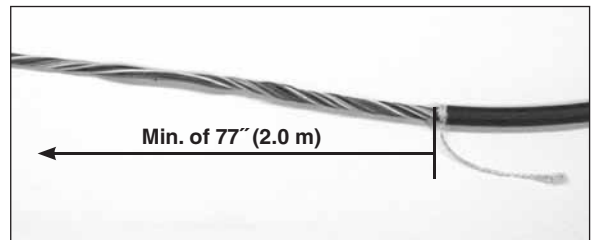

Minimum Sheath Opening for Cut Cable Applications

| | |
|----------|------------|
| 77" Min. | 2.0 m Min. |
|----------|------------|

PLP Tip: Leave about 8" (203 mm) of strength member to trim later.

Step #9 Prepare loose tube/buffer tube or unitube/
ribbon cable(s) for mid sheath applications
(Express/Balloon/Ring Cut).

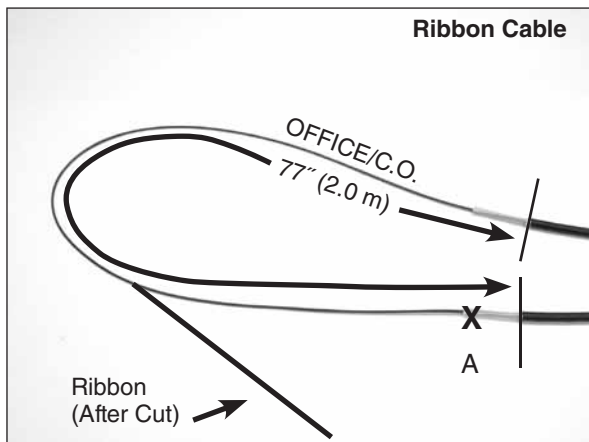
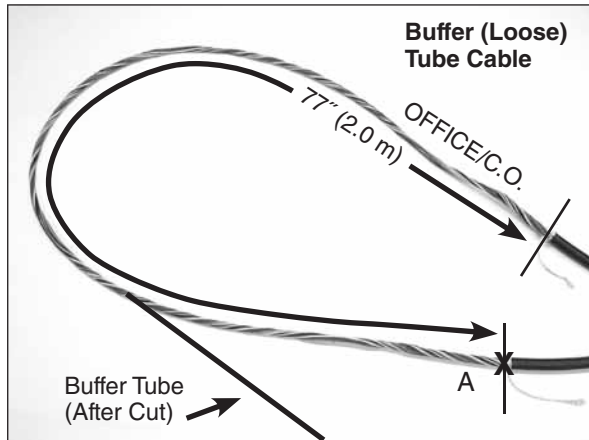

NOTE: When expressing ribbons in the transition tray of the closure at this measurement, the maximum number of ribbons that can be expressed is 24 ribbons (288 fibers).

| For Applications Where Fiber is Dedicated to the Splice Point | |
|---|---------------------|
| Sheath Opening | 77" (2.0 m) . |
| Fiber/Buffer Tube Cut Location | A (see image above) |

PLP Tip: Leave about 8" (203 mm) of strength member to trim later.

Step #10 Prepare loose tube/buffer tube or unitube/
ribbon cable(s) for mid sheath applications
(Express/Balloon/Ring Cut).

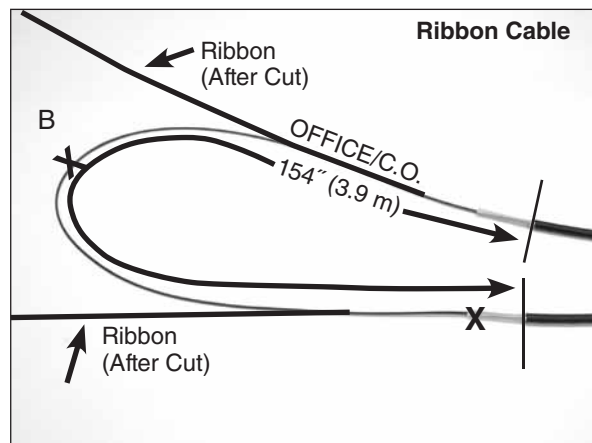
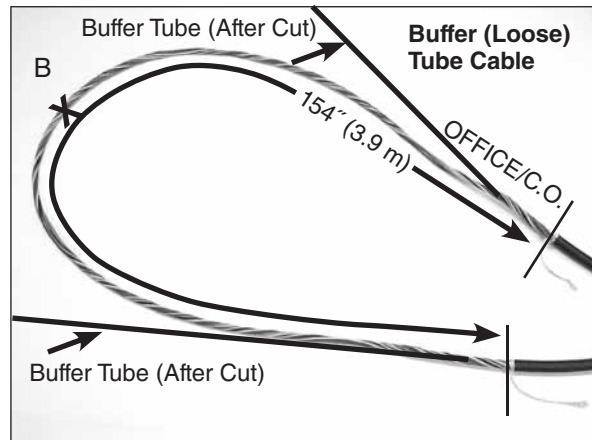

NOTE: When expressing ribbons in the transition tray of the closure at this measurement, the maximum number of ribbons that can be expressed is 12 ribbons (144 fibers).

| For Applications Where Fiber is NOT Dedicated to the Splice Point | |
|---|---------------------|
| Sheath Opening | 154" (3.9 m) |
| Fiber/Buffer Tube Cut Location | B (see image above) |

PLP Tip: Leave about 8" (203 mm) of strength member to trim later.

Step #11 Prepare loose tube/buffer tube cable(s) for expressed fiber (buffer tube window cut).

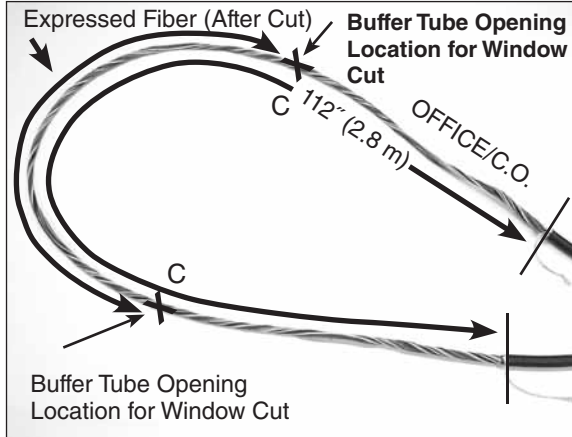

For Applications Where Fiber is Expressed through the Buffer Tube

| | |
|------------------------------|---------------------|
| Sheath Opening | 112" (2.8 m) |
| Buffer Tube Opening Location | C (see image above) |

PLP Tip: Leave about 8" (203 mm) of strength member to trim later.

Step #12 Prepare Central/Buffer Tube(s) for Unitube/Ribbon Cable Applications.

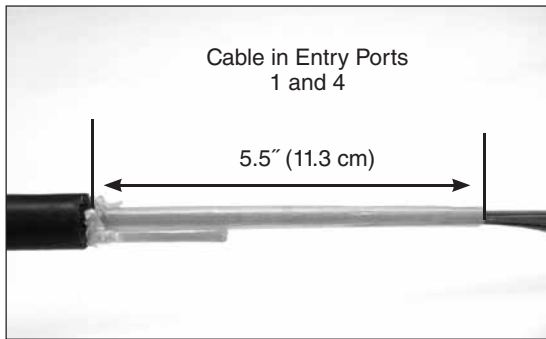

Step #13 If the cable contains Kevlar®, braid roughly 3" (7.2 cm) of the Kevlar.

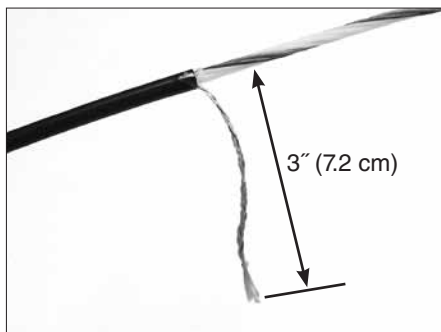

Step #14 Align sheath opening with end of slot of the strength member bracket as shown.

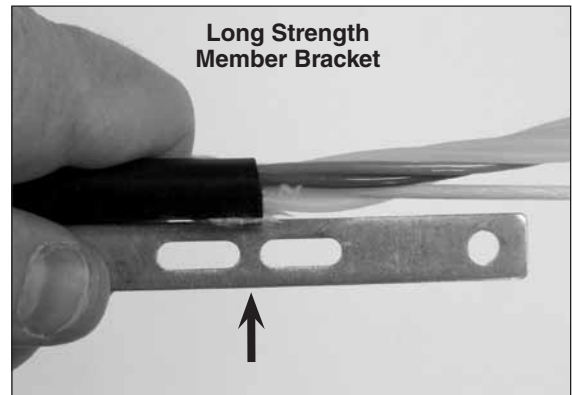
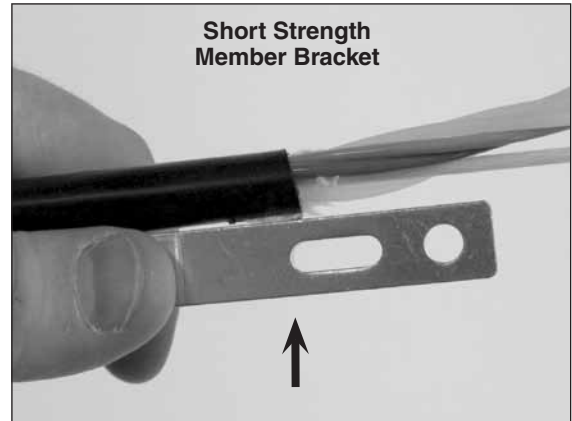

Step #15 Trim strength member(s) flush with end of the strength member bracket(s).

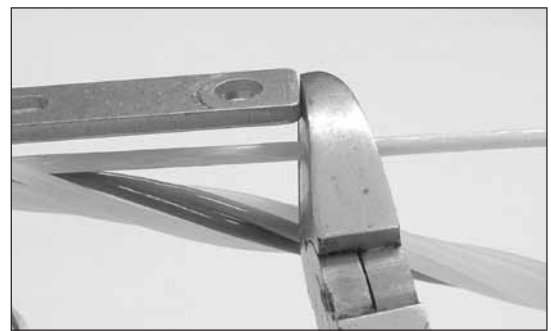

Step #16 Install cap on strength member bracket.



Step #17 Position strength member under cap of strength member bracket.



Step #18 If the cable contains Kevlar®, wrap the braided Kevlar around the stud of the cap as shown.

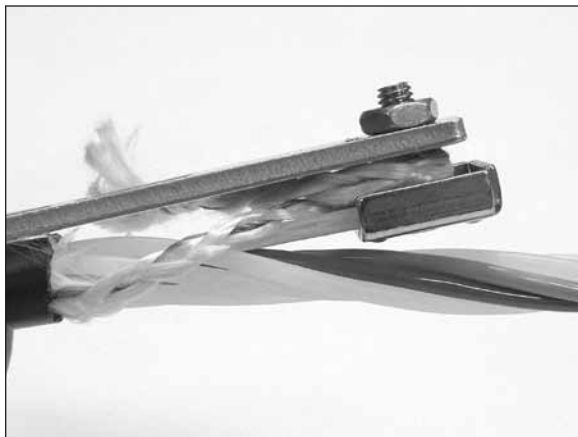

Step #19 Tighten nut of cap to secure strength member and braid under the cap.

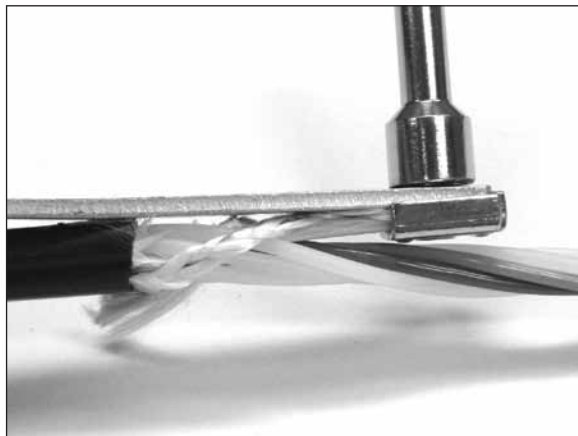

Step #20 Secure cable to strength member bracket with hose clamp.

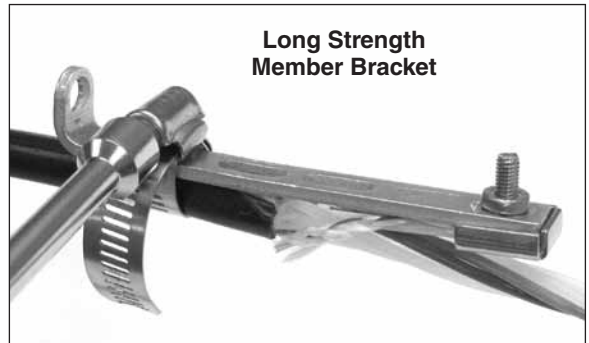
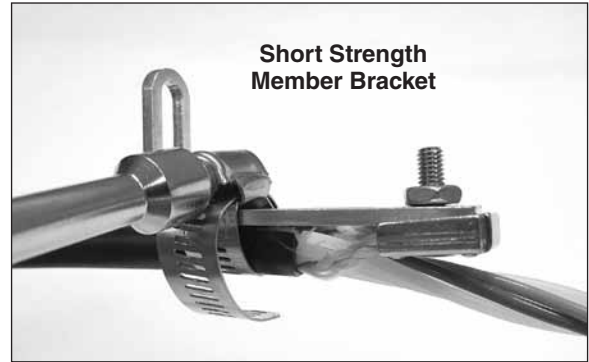

Installing Strength Member Adapter for Large Cable Strength Members

Step #21 For large cable strength members, assemble the adapter to the long strength member bracket as shown.

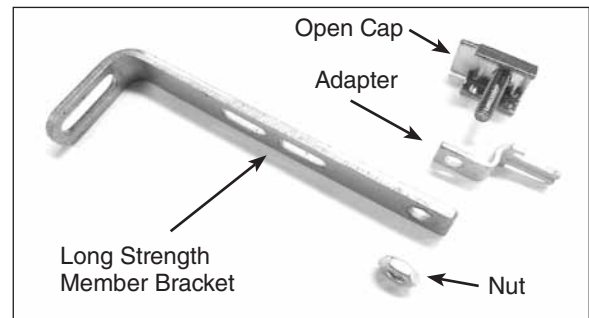

Step #22 Secure large cable strength member(s) to adapter with small hose clamp.

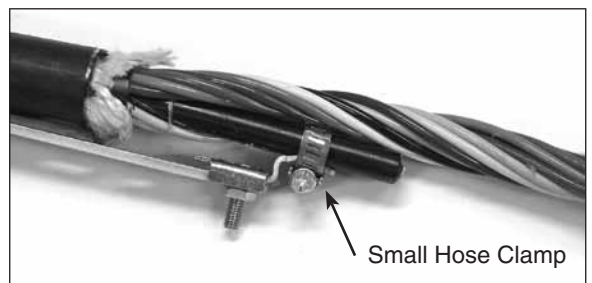

Step #23 If the cable contains Kevlar®, wrap the braided Kevlar around the stud of the cap as shown.

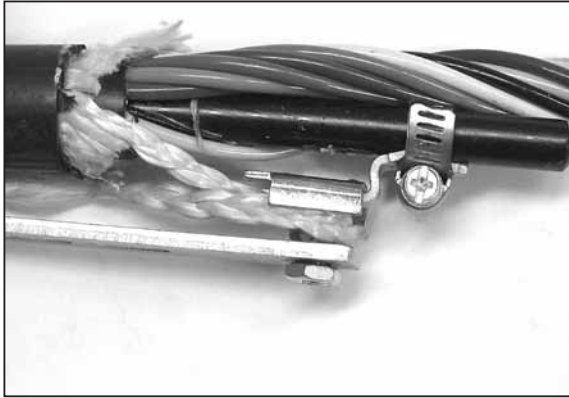

Step #24 Tighten nut of cap to secure under the cap.

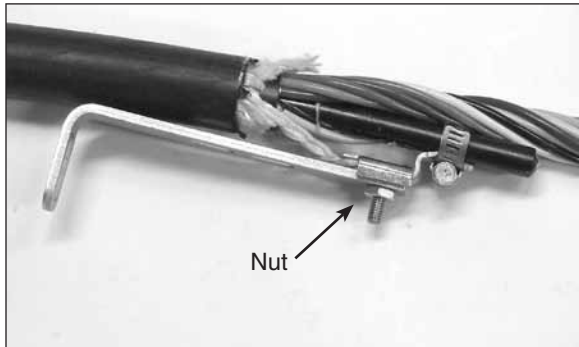

Step #25 Secure cable sheath with hose clamp.

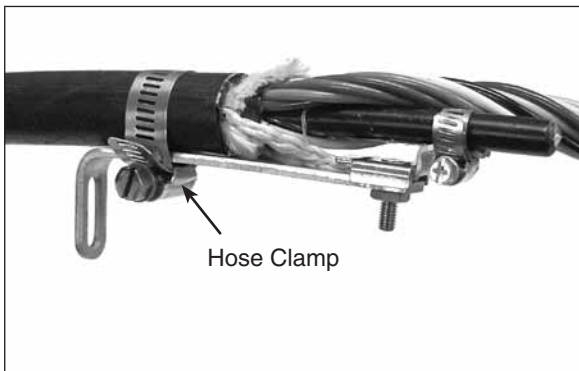

Attaching Shielded Cable to Strength Member Bracket

Step #26 For shielded cable applications, PLP recommends using a 3M 4460-D/FO Fiber Optic Shield Connector (PLP PN: 80803989), install shield connector on cable and insert stud of shield connector through slot of strength member bracket.

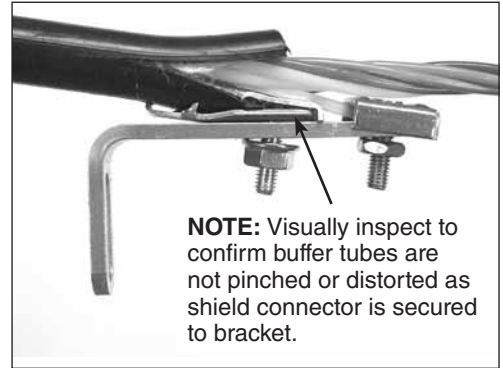

NOTE: Visually inspect to confirm buffer tubes are not pinched or distorted as shield connector is secured to bracket.

Follow standard company practices when applying shield connector to cable.

Step #27 Secure shield connector to strength member bracket with nut and secure cable strength member under cap of the strength member bracket.

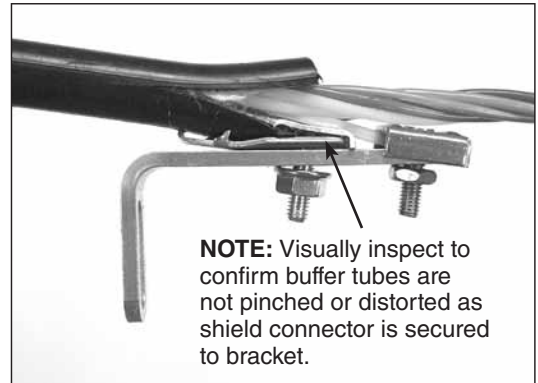

NOTE: Visually inspect to confirm buffer tubes are not pinched or distorted as shield connector is secured to bracket.

Step #28 Secure shielded cable to strength member bracket with hose clamp.

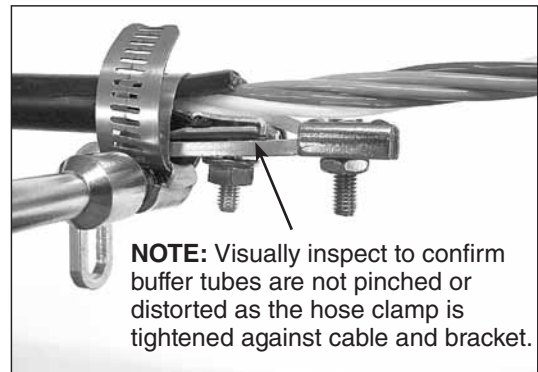

NOTE: Visually inspect to confirm buffer tubes are not pinched or distorted as the hose clamp is tightened against cable and bracket.

Step #29 Lubricate the outer surface of the grommet.

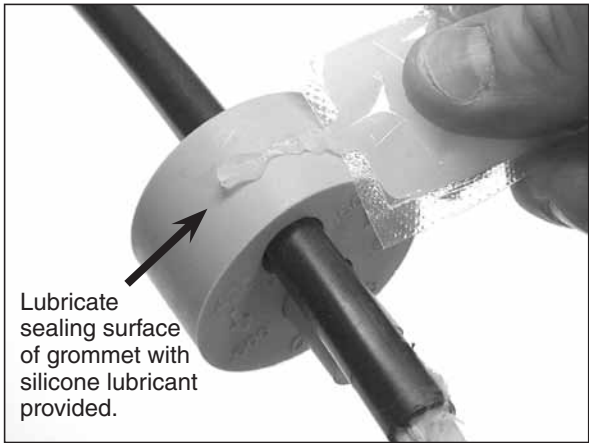

Step #32 Secure strength member bracket on stud with lock washer and nut.

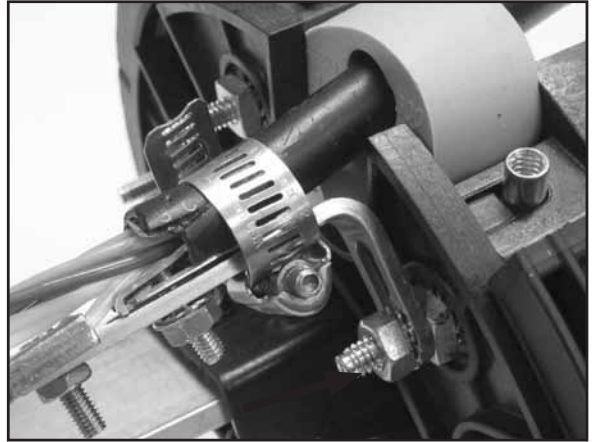

Step #30 Position grommet in end plate slot.

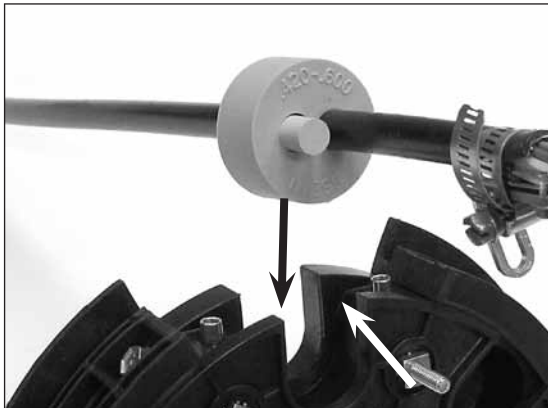

Do not align grommet slit with end plate seam.

Step #33 Install cable cap and secure with hex bolts.



NOTE: Tighten bolts by hand evenly until cable cap is fully seated (DO NOT USE POWER TOOLS TO TIGHTEN BOLTS).

NOTE: TIGHTEN ALL UNUSED CABLE CAPS.

Step #31 Position slot of strength member bracket leg over stud and pull back cable.

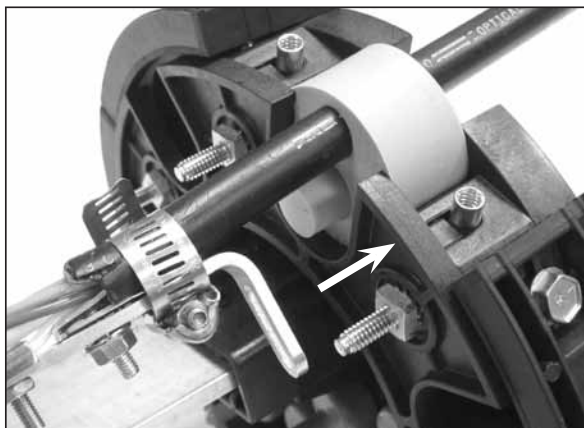

Step #34 Complete end plate assembly.



Step #35 Re-install end plate onto organizer assembly and secure with bolt.



Buffer Tube Applications

Step #36 Route and store buffer tubes in storage brackets. If routing in side storage brackets, see Step #28 for installation of retainer clips.

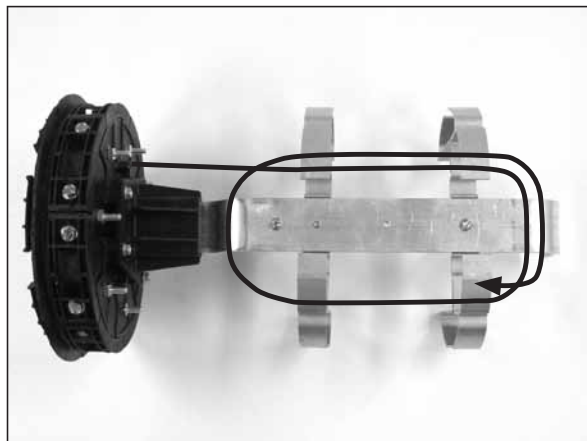
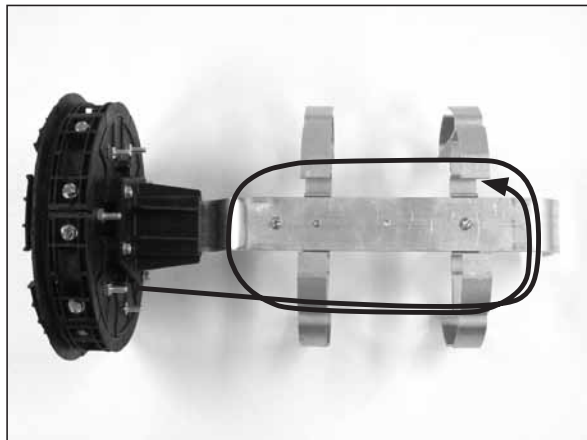

Step #37 To install retainer clip, position the bottom slot of the retainer clip onto the bottom of the bracket. Tilt retainer clip forward until the top of the bracket snaps into the top slot of the retainer clip.

Before



After



Step #38 Route buffer tube(s) to splice tray(s) and secure.

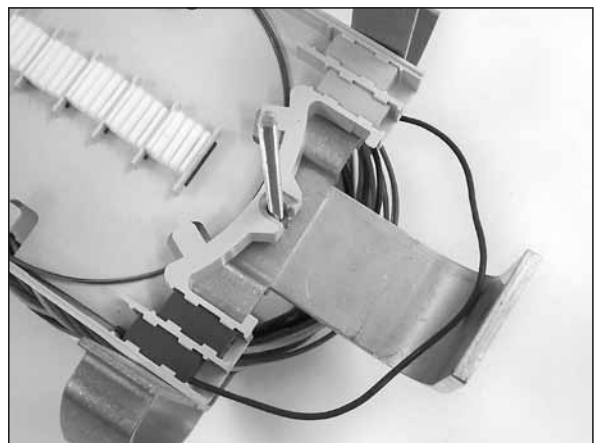

Unitube Applications

Step #39 Route and secure central tube of unitube cables to transition tray.

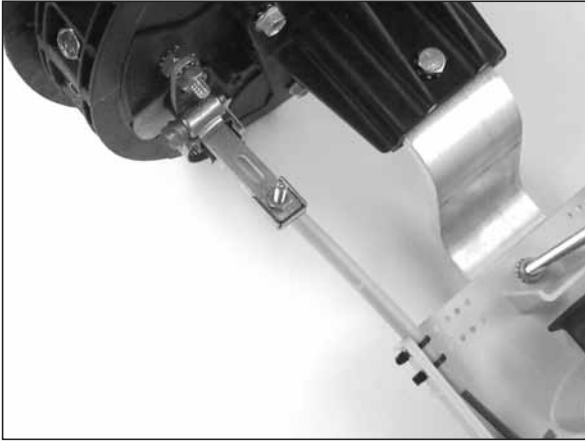

Step #40 Route feeder fibers or ribbons within transition tray.

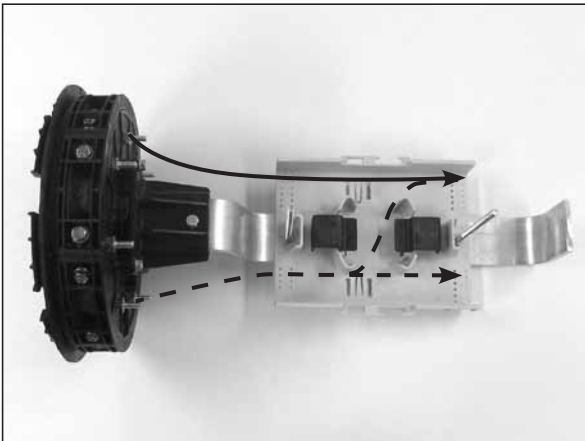

Step #41 Install organizer clips in transition tray and route expressed fibers or ribbons under clips.

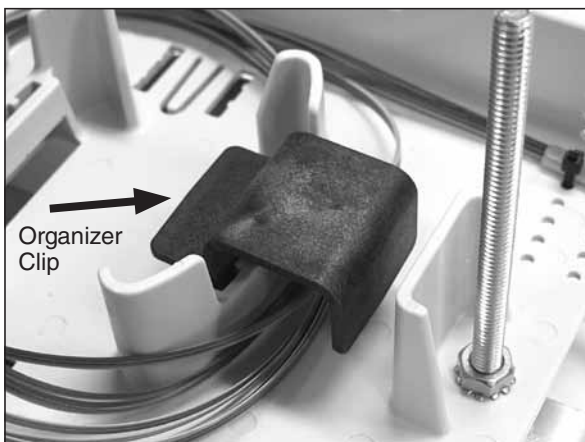

Step #42 Insert fibers or ribbons to be routed to splice tray(s) into transport tube(s) and secure tubes to transition tray.

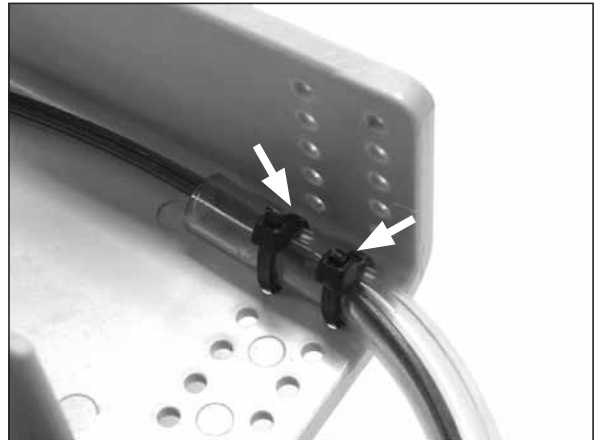

Step #43 Install cover on transition tray.

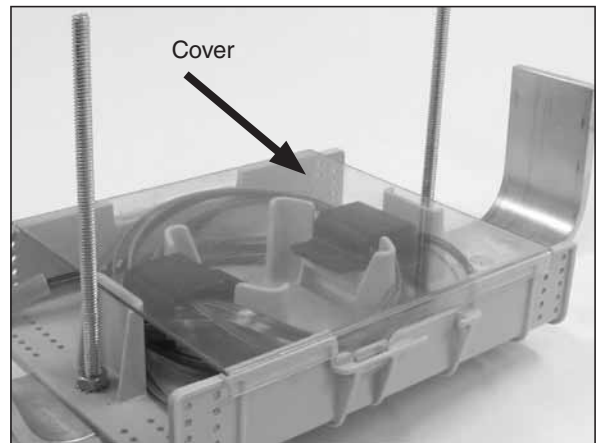

Step #44 Route transport tube(s) to splice tray(s) and secure.

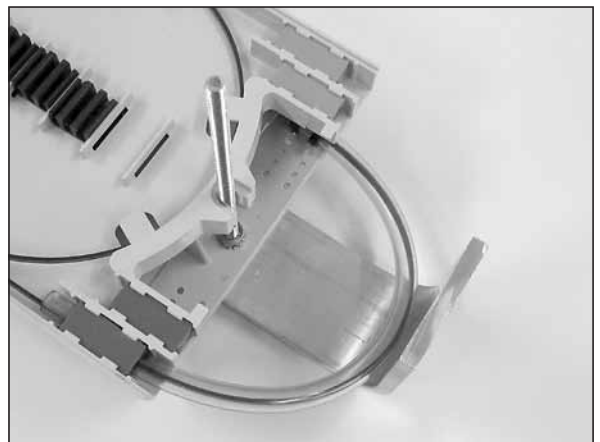

Splice Tray Management

Step #45 Route incoming fibers in splice tray.

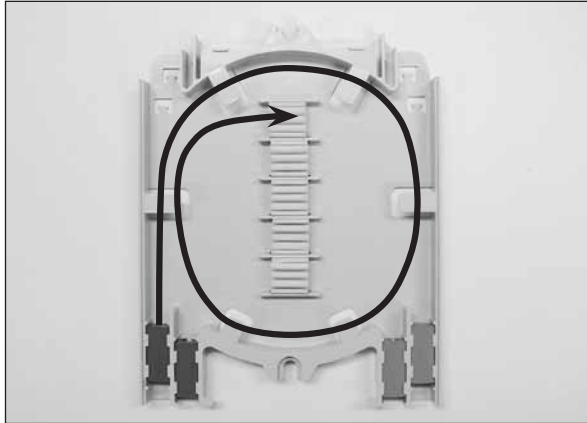

Step #46 Route outgoing fibers in splice tray.

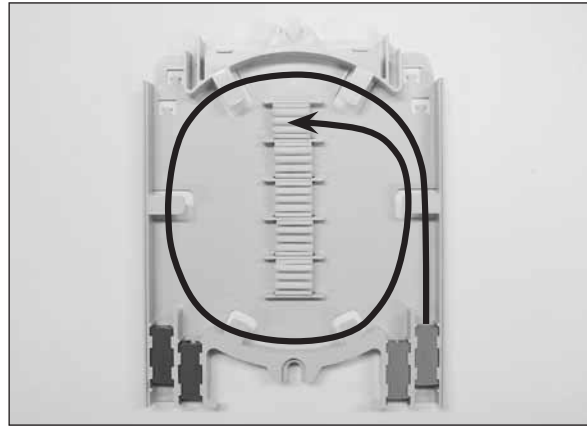

Step #47 Splice incoming fibers to outgoing fibers per your accepted company practices.

Step #48 Secure splice tray(s) with hold down strap.

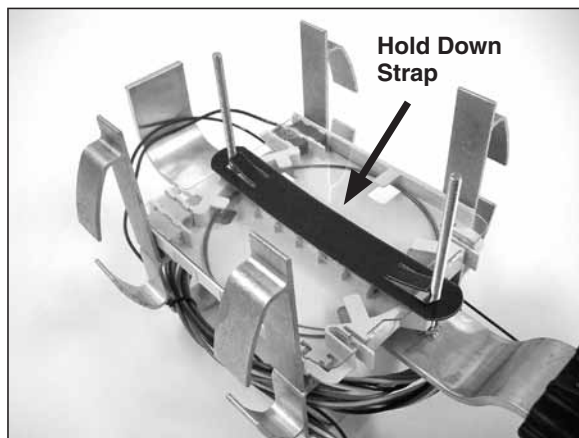

Dome Preparation & Installation

Step #49 Lubricate all surfaces around gasket with silicone lubricant to assure easy assembly and closure re-entry.

Lubricate all inner surfaces of the gasket.

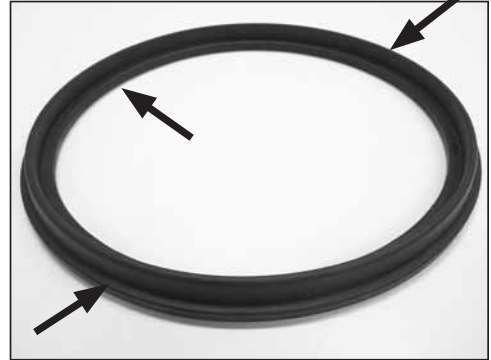

Lubricate all outer surfaces of the gasket.

Step #50 Slide end plate gasket onto end plate and press into groove.

Make sure gasket is fully seated in groove of end plate.

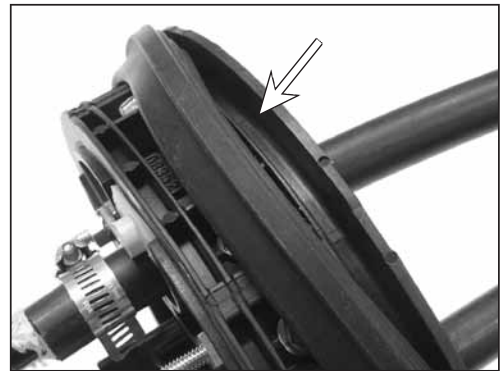

Step #51 Re-tighten all cable cap bolts (Step #33) to ensure that the cable caps are fully seated.

Step #52 Position dome over end plate.

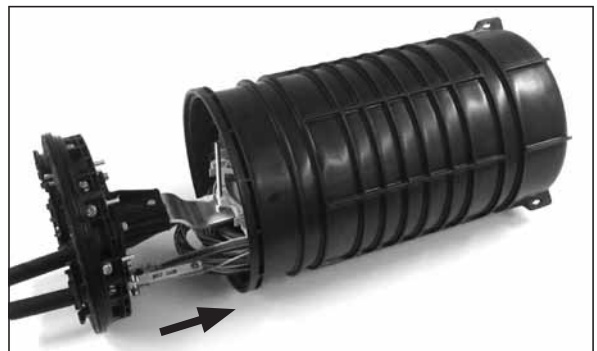

Step #53 Install dome collar.

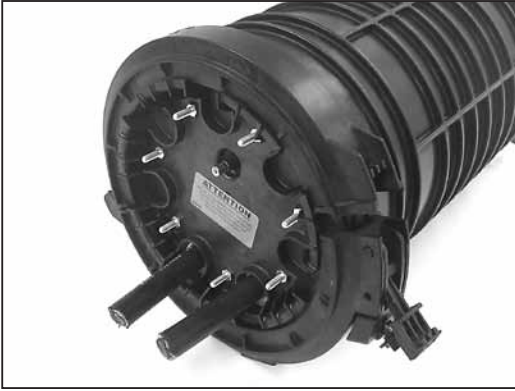

Step #54 Make sure lip of dome is captured underneath the collar before securing the latch.

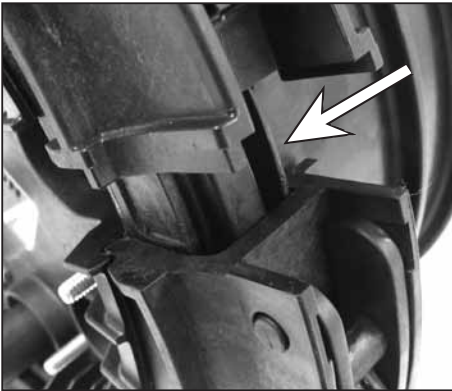

Lip of Dome

Step #55 Lock collar by twisting the latch fastener clockwise 90 degrees.

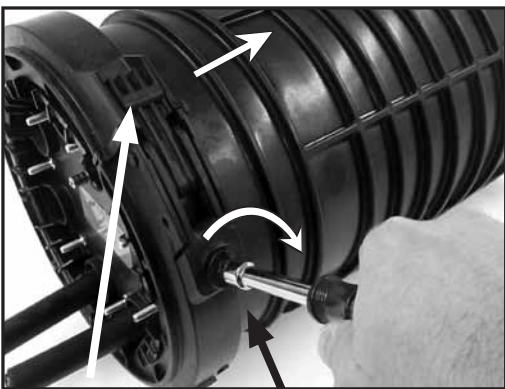

Latch Fastener

CAUTION: Do not fasten latch until collar is completely installed in the correct position or damage to latch may occur.

Flash Test to **10 psi** max.

Flash Test Procedure

Step #56 Remove cap from air valve of end plate.



Step #57 Pressurize closure up to a max of 10 psi.



Step #58 Spray all sealing surfaces of the dome end plate with soapy water to determine if there are any leaks.



Common End Plate Leaks During Flash Testing

Leak occurring at the corner of the cable port due to the cap of the cable port not being fully tightened.



Step #59 Release the pressure in the closure using the bump on the top of the air valve cap.

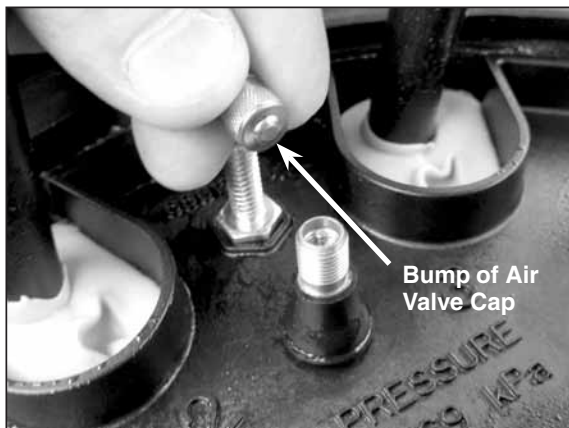

Leak occurring at the cable entry of the grommet due to the cable not being within the stated cable diameter range of the grommet.



Aerial Mounting Options

Step #60 9.5" (292 mm) COYOTE® Dome End Plate Mount Aerial Bracket. The COYOTE 9.5" Dome Aerial Mounting Bracket Kit (Cat. No. 8003941) can be used to suspend the COYOTE 9.5" x 19" (292 x 509 mm) or 9.5" x 28" (292 x 749 mm) dome closure from messenger wire. To install the aerial mounting bracket, first secure the gusset bracket to the hanger bracket before attaching both to the studs of dome end plate. Next, attach the dome bracket to the mounting tabs of the dome. Lastly, attach a hanger strap bracket to the dome bracket and one to the back side of the hanger bracket before mounting the dome closure to the messenger wire using the bug nuts of the hanger strap brackets.

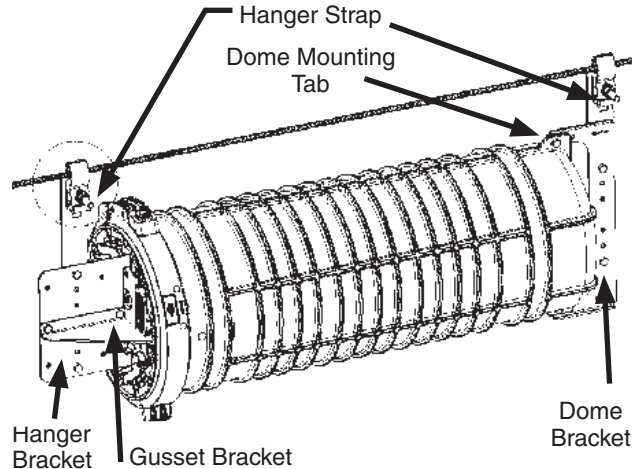

Step #61 9.5" (292 mm) COYOTE Dome Mount Aerial Bracket. The COYOTE 9.5" Dome Mount Aerial Bracket Kit (Cat. No. 8003940) can be used to suspend the COYOTE 9.5" x 19" (292 x 509 mm) or 9.5" x 28" (292 x 749 mm) dome closure from messenger wire. To install the dome mount aerial brackets, position the brackets in the banding channels of the dome and insert banding (plastic or metal) through the slots of the brackets. Tighten the banding until the brackets are secure before mounting the closure to the messenger wire with the bug nuts of the brackets.

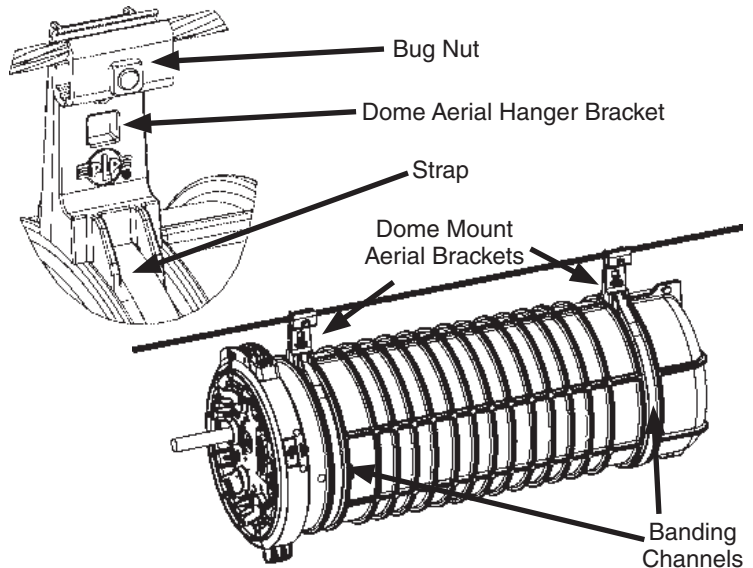

Step #62 9.5" (292 mm) COYOTE Dome Mount Aerial Bracket – for ADSS Applications. The COYOTE 9.5" Dome Mount Aerial Bracket Kit for ADSS (Cat. No. 8003869) can be used to suspend the COYOTE 9.5" x 19" (292 x 509 mm) or 9.5" x 28" (292 x 749 mm) dome closure from ADSS cable. To install the Dome Mount Aerial Brackets, position the brackets in the banding channels of the dome and insert banding (plastic or metal) through the slots of the brackets. Tighten the banding until the brackets are secure before mounting the closure to the ADSS cable with the ADSS clamp.

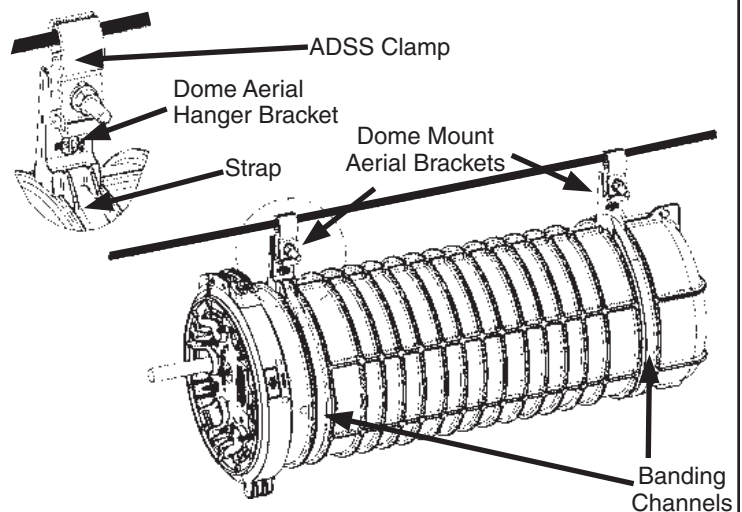

Step #63 Offset Aerial Hanger Bracket Kits

PN:8004037 for Strand Mount Applications



PN:8004038 for ADSS Applications



Bracket installed on dome closure for shorter spacing. Second bracket also installed on opposite end of dome.

Pole/Wall Mounting Options

Step #64 Pole/Wall Mount Bracket Kit - PN:8003942

Place the bolts through the stud mount plate as shown and install lock nuts on bolts until there is a 1/8" (3 mm) gap between the nut and the stud mount plate.

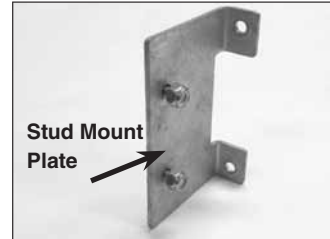

Step #65

Slide the bolts of the stud mount plate into the slots of the pole/wall mount bracket as shown and tighten the lock nuts until the plates are secure.

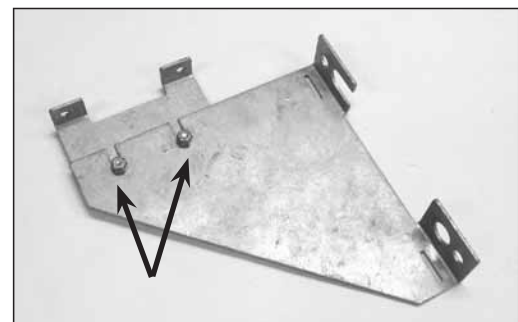
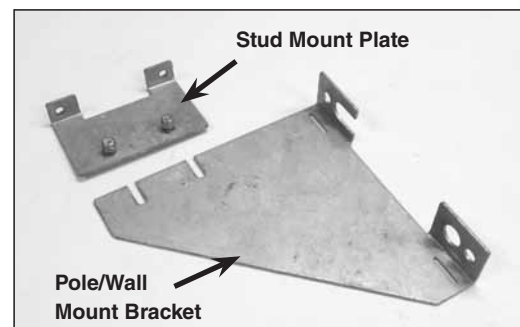

Step #66 Attach the dome pole/wall mount bracket to a pole or wall with either 5/8" through bolts, 1/4" lag screws, or banding straps.

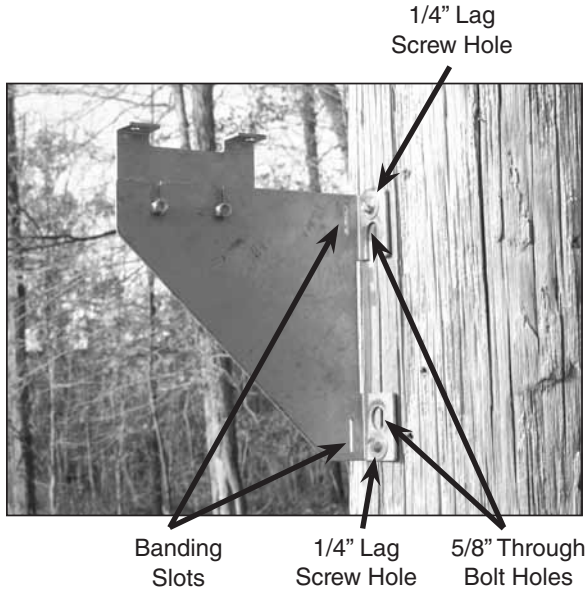

Step #67 Attach the COYOTE® Dome closure to the pole/wall mount bracket by inserting the studs of the dome closure end plate and securing with the lock nuts provided.

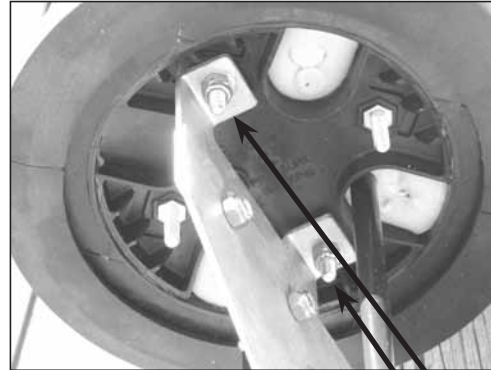

Secure Lock Nuts

SAFETY CONSIDERATIONS

This application procedure is not intended to supersede any company construction or safety standards. This procedure is offered only to illustrate safe application for the individual. **FAILURE TO FOLLOW THESE PROCEDURES MAY RESULT IN PERSONAL INJURY OR DEATH.**

Do not modify this product under any circumstances.

This product is intended for use by trained technicians only. **This product should not be used by anyone who is not familiar with, and not trained to use it.**

When working in the area of energized lines, extra care should be taken to prevent accidental electrical contact.

For proper performance and personal safety, be sure to select the proper size PREFORMED™ product before application.

PREFORMED products are precision devices. To insure proper performance, they should be stored in cartons under cover and handled carefully.



PREFORMED LINE PRODUCTS

P.O. Box 91129, Cleveland, Ohio 44101 • 440.461.5200 • www.preformed.com • e-mail: inquiries@preformed.com

SP3138-1