



Multicom Product Catalog

TABLE OF CONTENTS

	SECTION
OUTSIDE PLANT	A
FIBER MANAGEMENT	B
FIBER OPTIC HEADEND & TERMINATION	C
SATELLITE DISHES & LNBS	D
INDOOR PRODUCTS	E
IT / DATA PRODUCTS	F
TOOLS & TEST EQUIPMENT	G

2016
www.multicominc.com

SECTION A

OUTSIDE PLANT	PAGE
COAX CABLE	
• DROP CABLE - RG-59, RG-6, RG-11	3
• TRUNK CABLE - .500 & .540	5
• HEAT SHRINK TUBING	9
TRUNK CONNECTORS	10
FIBER CABLE	12
• ADSS	13
• ARMoured	
TAPS & PASSIVES	19
OUTDOOR NODES	
• 4 PORT NODES	23
• NODE SERVICE CABLE	25
TERMINATION	
• See all of the Multicom Nodes in SECTION C	

BACK TO MAIN TABLE OF CONTENTS



Drop Cable

Product Specifications

Key Features

Cable Type	Part #	Braid %	Color/Description
RG-59	M5960-BV	60%	Black
RG-59	M5960-BVV	60%	Black/CATV UL Listed
RG-6	M660-BV	60%	Black
RG-6	M660-BVW	60%	White
RG-6	M660-BVV	60%	Black/CATV UL Listed
RG-6	M660-BVWV	60%	White/CATV UL Listed
RG-6	M660-BVM	60%	Black/Messenger
RG-6	M660-BEF	60%	Black/Flooded
RG-6	M6Q-BVV	60%/90%	QUAD Shield, CATV UL Rated
RG-6	M690-BV	90%	Black
RG-6	M690-BVW	90%	White
RG-6	M690-BVV	90%	Black/CATV UL Listed
RG-6	M690-BVWV	90%	White/CATV UL Listed
RG-6	M690-BVM	90%	Black/Messenger
RG-6	M660T-BVS	60%	SCTE Compliant, Tri-Shield
RG-11	M1160-BV	60%	Black
RG-11	M1160-BVV	60%	Black/CATV UL Listed
RG-11	M1160-BVM	60%	Black Messenger
RG-11	M1160-BEF	60%	Black/Flooded
RG-11	M1190-BV	90%	Black
RG-11	M1190-BVV	90%	Black/CATV UL Listed
RG-11	M1190-BVM	90%	Black/Messenger

Features:

- PVC Jacket
- Foam Dielectric
- Swept to 3,500 MHz
- Impedance - 75 Ohm
- 1,000 Foot Reels
- CATV UL Listed Available
- Black or White
- Copper Clad Steel Center Conductor
- Messenger, Flooded, Tri-Shield
- 60%, 90% Aluminum Braid

Frequency MHz	RG-59	RG-6	RG-11
	db/100 Ft/M	db/100 Ft/M	db/100 Ft/M
5 MHz	0.89 / 2.92	0.96 / 2.26	0.38 / 1.25
55 MHz	1.95 / 6.40	1.60 / 5.25	0.97 / 3.18
211 MHz	3.59 / 11.78	2.87 / 9.41	1.81 / 5.94
450 MHz	5.30 / 17.38	4.26 / 13.97	2.65 / 8.69
550 MHz	5.90 / 19.35	4.71 / 15.45	2.94 / 9.64
750 MHz	6.96 / 22.83	5.59 / 18.34	3.44 / 11.28
870 MHz	7.54 / 24.73	6.00 / 19.68	3.84 / 12.60
1000 MHz	8.09 / 26.54	6.54 / 21.45	4.23 / 13.87
1450 MHz	10.54 / 34.57	8.30 / 27.22	5.07 / 16.63
2250 MHz	13.70 / 44.94	10.60 / 34.77	6.50 / 21.32
3000 MHz	15.50 / 50.84	11.90 / 39.03	7.67 / 25.16
3500 MHz	16.74 / 54.91	12.85 / 42.15	8.28 / 27.16

Part# Matrix:

M660T-BVWV

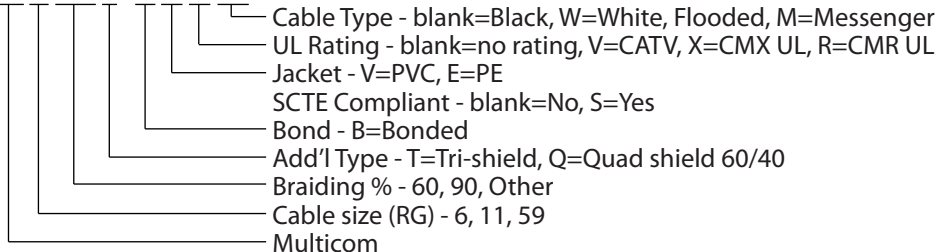

Society of Cable
Telecommunications
Engineers

www.multicominc.com

Multicom, Inc.
Ph: 407-331-7779
Fax: 407-339-0204

Email: multicom@multicominc.com



RG-6 Tri-Shield Drop Cable Product Specifications



Construction Materials*	
Jacket Material	PVC
Center Conductor Material	Copper Clad Steel
Dielectric Material	Foam PE
Inner Shield (Braid) Coverage	60%
Inner Shield (Braid) Gauge	34 AWG (.0063")
Inner Shield (Braid) Material	Aluminum
Inner Shield (Tape) Material	Aluminum/Polymer/Aluminum (APA) bonded
Outer Shield (Tape) Material	Aluminum/Polymer/Aluminum (APA)

Dimensions*	
Diameter Over Center Conductor, nominal	1.016mm - 0.040"
Diameter Over Dielectric, nominal	4.57mm - 0.180"
Diameter Over Inner Shield (Tape), nominal	4.75mm - 0.187"
Diameter Over Jacket, nominal	7.06mm - 0.278"
Jacket Thickness, nominal	0.76mm - 0.030"
Shipping Weight	32 lbs.

Electrical Specifications*	
dc Resistance, Inner Conductor, nominal	23.35 ohms @ 1,000'
dc Resistance, Outer Conductor, nominal	5.90 ohms @ 1,000'
dc Resistance, Loop, nominal	28.95 ohms @ 1,000'
Characteristic Impedance	75 ohms
Characteristic Impedance Tolerance	±3 ohms
Nominal Velocity of Propagation (NVP)	82%

General Specifications*	
Cable Type	RG-6
Packaging Type	1,000' Reel
Shield Construction Type	Tri-Shield
Center Construction Gauge	18 AWG (.0403")
Center Conductor Type	Solid
Jacket Color	Black
Jacket Marking	Feet
RoHS 2011/65/EU	Compliant
ISO 9001:2008	Designed, manufactured and/or distributed under this management system
Compliance	*All specifications meet or surpass SCTE 74 2011 Specifications

Maximum Attenuation**		
Frequency (MHz)	dB/100ft	dB/100m
5	0.58	1.90
55	1.60	5.25
211	3.05	10.00
250	3.30	10.82
270	3.37	11.04
300	3.55	11.64
330	3.74	12.26
350	3.85	12.63
400	4.15	13.61
450	4.40	14.43
500	4.66	15.29
550	4.90	16.08
600	5.10	16.73
750	5.65	18.54
870	6.11	20.04
1000	6.55	21.49

Features:

- 18 AWG copper covered steel center conductor
- Gas expanded polyethylene dielectric
- 1,000 foot reels
- Swept to 3,500 MHz
- Inner shield: Aluminum-polypropylene-aluminum laminated tape with overlap bonded to dielectric
- Outer shield: 34 AWG aluminum braid
- Tri-shield: Double-side unbonded aluminum foil
- Jacket: PVC
- Braid: 60% aluminum

Part# M660T-BVS

www.multicominc.com

Multicom, Inc.
Ph: 800-423-2594 / 407-331-7779

Fax: 407-339-0204

Email: multicom@multicominc.com



Messenger Trunk Cable Extruded and Welded

Product Specifications

Category	Material	Diameter
Center Conductor	Copper Clad Aluminum	0.11" (2.77mm)
Dielectric	Micro-cellular foam PE	0.450" (11.43mm)
Outer Conductor	Seamless aluminum (Extruded tube)	0.025" (0.64mm)
Jacket	Polyethylene	0.57" (14.48mm)
Messenger	Steel Messenger	0.11" (2.77mm)
Characteristic	Specification	
Messenger Break Strength	1,800 lbs (816kgs)	
Min. Bend Radius	3.5" (89mm)	
Max. Pulling Tension	300 lbs. (136kgs)	
Nominal Impedence	75 ±2 Ohms	
Capacitance	15.3 ±1.0 pf/ft (50 ±2.0 nf/km)	
Velocity of Propagation	87% Nominal	
DC Breakdown Voltage	5.0kV	
DC Loop Resistance	1.72 Ohms/1,000 ft (5.65 Ohms/km)	

Attenuation at 68°F (20°C)

M500-JCAM109 and M500-JCAM109W		
Frequency	db/100 Ft.	db/100 M.
5 MHz	0.16	0.52
55 MHz	0.54	1.77
83 MHz	0.66	2.17
211 MHz	1.09	3.58
250 MHz	1.20	3.94
300 MHz	1.31	4.30
350 MHz	1.43	4.69
400 MHz	1.53	5.02
450 MHz	1.63	5.35
550 MHz	1.82	5.97
600 MHz	1.91	6.27
750 MHz	2.16	7.09
865 MHz	2.34	7.68
1000 MHz	2.52	8.27



Multicom's Extruded and Welded Messenger Trunk Cable is manufactured in an ISO 9001 Certified facility and has specifications that exceed industry standards - with low attenuation and inherent strength. Its proven performance and reliability make it the right choice for distribution applications.

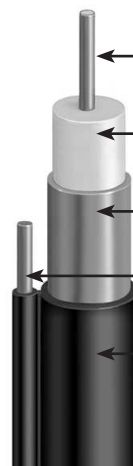

Center Conductor

Dielectric

Seamless Aluminum (Extruded tube) Shield or Argon Welded Aluminum Tube Shield (see Part#s below)

Steel Messenger

PE Jacket

Part# M500-JCAM109

Seamless Aluminum (Extruded tube) Shield

Part# M500-JCAM109W

Argon Welded Aluminum Tube Shield

www.multicominc.com

Multicom, Inc.

Ph: 407-331-7779

Fax: 407-339-0204

Email: multicom@multicominc.com



.500 Trunk Cable Product Specifications

Construction Materials*	
Jacket Material	PE
Center Conductor Material	Copper Clad Aluminum
Dielectric Material	PE
Construction Type	Seamless Extruded
Messenger Wire Material	Galvanized Steel
Outer Conductor Material	Aluminum

Dimensions*	
Diameter Over Center Conductor, nominal	2.769mm - 0.109"
Diameter Over Dielectric, nominal	11.430mm - 0.450"
Diameter Over Outer Conductor, nominal	12.700mm - 0.500"
Diameter Over Jacket, nominal	14.224mm - 0.560"
Diameter Over Messenger Wire, nominal	2.769mm - 0.109"
Jacket Thickness, nominal	0.7620mm - 0.0300"
Outer Conductor Thickness, nominal	0.6096mm - 0.0240"
Cable Length	732m - 2,400"
Shipping Weight	176 lbs @ 1,000'

Electrical Specifications*	
dc Resistance, Inner Conductor, nominal	1.35 ohms @ 1,000'
dc Resistance, Outer Conductor, nominal	0.37 ohms @ 1,000'
dc Resistance, Loop, nominal	1.72 ohms @ 1,000'
Characteristic Impedance	75 ohm
Characteristic Impedance Tolerance	±2 ohm
Nominal Velocity of Propagation (NVP)	87%
Jacket Spark Test Voltage	5000Vac
Operating Frequency Band	5-1000 MHz
Structural Return Loss	30 dB @ 5-1000 MHz

General Specifications*	
Cable Type	.500 Trunk
Environmental Space	Aerial
Jacket Color	Black
Packaging Type	Reel

Mechanical Specifications*	
Messenger Wire Breaking Strength, minimum	816 kg - 1,800 lbs
Minimum Bend Radius, bonded	88.90mm - 3.50"
Minimum Bend Radius, standard	152.40mm - 6.00"
Pull Tension, maximum	136 kg - 300 lbs

Maximum Attenuation*		
Frequency (MHz)	dB/100ft	dB/100m
5	0.16	0.52
55	0.55	1.80
211	1.09	3.58
250	1.20	3.94
270	1.24	4.06
300	1.31	4.30
330	1.38	4.53
350	1.43	4.69
400	1.53	5.02
450	1.63	5.35
500	1.73	5.67
550	1.82	5.97
600	1.92	6.30
750	2.17	7.12
870	2.35	7.69
1000	2.53	8.30

Compliance	*All specifications meet or surpass SCTE 15 2006 Specifications
------------	---

Description:

Multicom's High Performance SCTE-Compliant Trunk Cable is manufactured under the ISO 9001:2008 quality management system to meet or surpass industry standards. With low attenuation and inherent strength - its proven performance and reliability make it the right choice for distribution applications.



Part# M500-JCAM109S

www.multicominc.com

Multicom, Inc.
 Ph: 800-423-2594 / 407-331-7779
 Fax: 407-339-0204
 Email: multicom@multicominc.com



Multicom Welded Messenger Trunk Cable

Product Specifications

Category	Material	Diameter
Center Conductor	Copper Clad Aluminum	0.124 inches (3.15mm)
Dielectric	Micro-cellular foam PE	0.514 inches (13.03mm)
Outer Conductor	Argon welded aluminum	0.540 inches (13.72mm)
Jacket	Polyethylene	0.618 inches (15.49mm)
Messenger	Steel Messenger	0.109 inches (2.77mm)
Characteristic	Specification	
Messenger Break Strength	1800 lbs (8007kgs)	
Min. Bend Radius	6.5 inches (165mm)	
Max. Pulling Tension	220 lbs (100kgs)	
Nominal Impedence	75 ±2 Ohms	
Capacitance	50 ±3pF/m	
Velocity of Propagation	87% Nominal	
DC Breakdown Voltage	5 kV	
DC Loop Resistance	5.4 Ohms/km	

Attenuation at 68°F (20°C)

M540-JCAM109W		
Frequency	db/100 Ft.	db/100 M.
5 MHz	0.14	0.46
55 MHz	0.47	1.54
83 MHz	0.58	1.90
211 MHz	0.95	3.12
250 MHz	1.03	3.38
300 MHz	1.13	3.71
350 MHz	1.23	4.03
400 MHz	1.32	4.33
450 MHz	1.40	4.60
550 MHz	1.56	5.12
600 MHz	1.64	5.38
750 MHz	1.85	5.56
865 MHz	2.00	6.07
1000 MHz	2.17	7.12



Multicom's Trunk Cable is manufactured in an ISO 9001 Certified facility and has specifications that exceed industry standards - with low attenuation and inherent strength. Its proven performance and reliability make it the right choice for distribution applications.

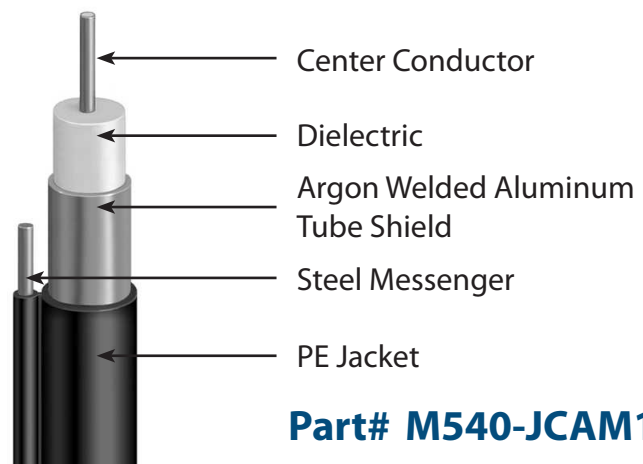

Part# M540-JCAM109W

www.multicominc.com

Multicom, Inc.
Ph: 407-331-7779
Fax: 407-339-0204

Email: multicom@multicominc.com



Multicom Welded Trunk Cable

Product Specifications

Category	Material	Diameter
Center Conductor	Copper Clad Aluminum	0.124 inches (3.15mm)
Dielectric	Micro-cellular foam PE	0.514 inches (13.03mm)
Outer Conductor	Argon welded aluminum	0.540 inches (13.72mm)
Jacket	Polyethylene	0.618 inches (15.49mm)
Characteristic	Specification	
Min. Bend Radius	6.5 inches (165mm)	
Max. Pulling Tension	220 lbs (100kgs)	
Nominal Impedence	75 ±2 Ohms	
Capacitance	50 ±3pF/m	
Velocity of Propagation	87% Nominal	
DC Breakdown Voltage	5 kV	
DC Loop Resistance	5.4 Ohms/km	

Attenuation at 68°F (20°C)

M540-JCA-W		
Frequency	db/100 Ft.	db/100 M.
5 MHz	0.14	0.46
55 MHz	0.47	1.54
83 MHz	0.58	1.90
211 MHz	0.95	3.12
250 MHz	1.03	3.38
300 MHz	1.13	3.71
350 MHz	1.23	4.03
400 MHz	1.32	4.33
450 MHz	1.40	4.60
550 MHz	1.56	5.12
600 MHz	1.64	5.38
750 MHz	1.85	5.56
865 MHz	2.00	6.07
1000 MHz	2.17	7.12



Multicom's Trunk Cable is manufactured in an ISO 9001 Certified facility and has specifications that exceed industry standards - with low attenuation and inherent strength. Its proven performance and reliability make it the right choice for distribution applications.

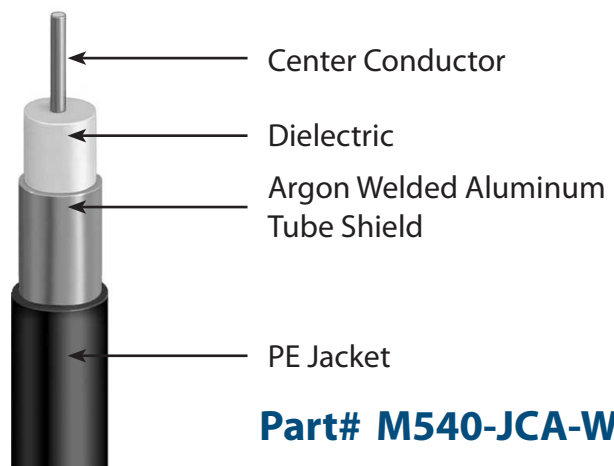

Part# M540-JCA-W

www.multicominc.com

Multicom, Inc.
Ph: 407-331-7779
Fax: 407-339-0204

Email: multicom@multicominc.com



Heat Shrink Tubing



Key Features

- Standard 48 inch lengths
- 1.5 inch inner diameter
- 52 mil wall thickness
- For .500 to .750 coax cable
- Easy to cut
- For use in aerial and below ground connections
- 10 tubes to a bag, 5 bags to a box

Description

Multicom's heavy-duty heat shrinkable tubing is designed for aerial and direct burial connections in CATV wiring including splices, taps, amplifiers and splitters. When the tubing is heated with either a heat gun or torch, the lining of adhesive sealant will flow for easy sealing and bonding.

M-HST-1500

www.multicominc.com

Multicom, Inc.
Ph: 800-423-2594
Fax: 407-339-0204

Email: multicom@multicominc.com



Trunk Connectors

Key Features

- Aluminum Alloy with Chromate Finish
- High RF performance in pedestal or straight through configurations
- "O" Ring Seals

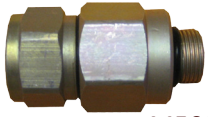

M500B-T10

The 500 Feed Thru Connector seizes the outer and center conductor of the coaxial cable. The cable center conductor extends thru this type of connector and is retained within the equipment housing.



M500-CH3-T10

The three-piece 500 Pin Type Connector seizes the outer and center conductor of the coaxial cable. A solid brass pin seizes and retains the cable center conductor. The pin then extends thru the body and is retained within the equipment housing.

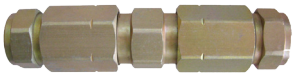

M500-SP-T10

The 500 Splice Connector is used to join together two cables. It also seizes the outer and center conductors of the cable.



M-TRM

The Housing Terminator Connector is used in cable systems where it becomes necessary to terminate the RF signal power. It also seizes the outer and center conductors of the cable.



MF-625-CH

The KS Male to F-Female adapter is used to change from Housing to F-Female Connector.



M500-BAFF-T10

The 500 to F-Female Connector is used when an F-Female port is required at the end of a cable. It also seizes the outer and center conductors of the cable.



M-90

The 90° Adaptor is designed for pedestal type installations where space restrictions require a right-angle connection between equipment and coaxial cables.



M-HSG-HSG

The Housing to Housing Connector eliminates the need for jumpers and allows the connection of equipment without cable.

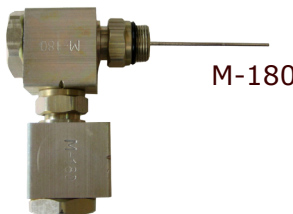

M-180

The 180° Adaptor provides the connection between the amplifier and cable connector in a restricted space.

Call for Pricing and Availability

www.multicominc.com

Multicom, Inc.

Ph: 800-423-2594

Fax: 407-339-0204

Email: multicom@multicominc.com



Trunk Connectors

Key Features

- Aluminum Alloy with Chromate Finish
- High RF performance in pedestal or straight through configurations
- "O" Ring Seals

Adapters are essential components to configure equipment for aerial and underground applications and are used to change the direction of the cable where space is limited or where tight bends are required. Our adapters allow room to economize the enclosures installed on municipal and customer properties. They eliminate the need for excess splicing in system rebuilds and reduce the number of cables damaged through tight bending radiuses and other installation challenges.



Multicom's 180 degree coaxial adapter designed for applications where space limitations require a 180 degree connection between cable and equipment. The design provides high current carrying capacity and exceptional return and insertion loss characteristics through 1 GHz.

Part#	Description
MP-PA-3.0-T	180 with 3" Extension
MP-PA-4.5-T	180 with 4.5" Extension
MP-PA-6.0-T	180 with 6" Extension
M-EXT-3	Extension 3"
M-EXT-4.5	Extension 4.5"
M-EXT-6	Extension 6"

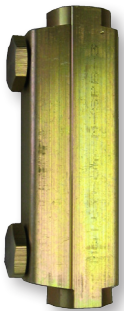

The Multicom Splice Block has been designed with superior electrical performance. The one-piece body is machined from an aluminum alloy to minimize moisture ingress paths. This product is designed to give high RF performance in pedestal or straight through configurations.

Part#	Description
M-SPB-2	Splice Block 2"
M-SPB-3	Splice Block 2.75"

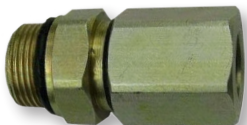

MCON-11
Multicom's housing to RG-11 Feed Thru Connector



MLT-1
Multicom's Locking Terminator



LTL-7 Locking Terminator Tool

Call for Pricing and Availability

www.multicominc.com

Multicom, Inc.

Ph: 800-423-2594

Fax: 407-339-0204

Email: multicom@multicominc.com



Speed, Distance, and Bandwidth

Fiber Optic Cable is the cable of today and the future. We have the fiber cable you need - and will cut and ship custom cable to where you need it, when you need it!

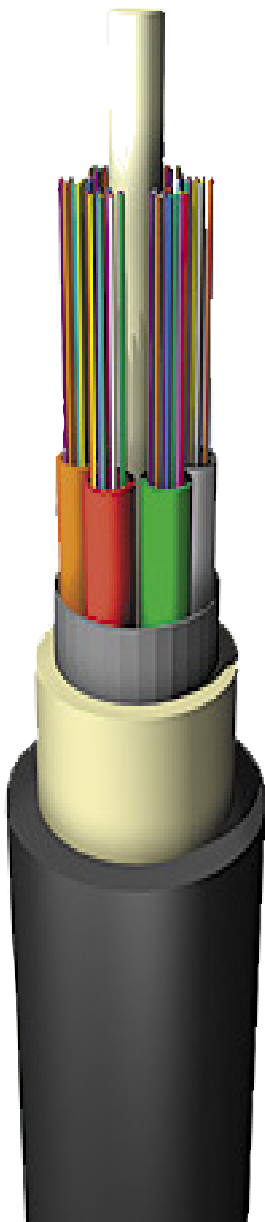

Fiber Optic Loose Tube Cable

Armored Cable

ADSS Cable

- » Single Mode and Multi-Mode
- » Reliable Lifetime Performance
- » Fiber Counts from 4 - 144
- » Multi-purpose Installation & Use
- » Flexible Routing & Termination
- » Easy Cable Entry & Preparation
- » All fiber counts and wavelengths
- » Future-proof
- » Industry-best prices - Call and compare

**Competitive Bids
IMSA Cable Specialists
Huge Inventory
Same Day Shipping**

**Multicom
Value Added
Services**

**Custom Cable Cutting
Expert and Experienced Sales Staff
Serving the industry since 1982**

**www.multicominc.com
800-423-2594**

Multicom, Inc.
1076 Florida Central Parkway
Longwood, FL 32750
Ph: 407-331-7779
Fax: 407-339-0204
Email: multicom@multicominc.com



Technical Specifications:
Self Supporting Aerial Installation Cable
 (According to ITU-T G.652)

Part Numbers:
 12 Count Fiber: MADSS012SM-350
 24 Count Fiber: MADSS024SM-350
 48 Count Fiber: MADSS048SM-350

1. GENERAL

1.1 SCOPE

This specification covers the design requirements and performance standard for T ~ |ca| { © optical fiber cableÈ

Cable type	Application
ADSS	Self support aerial installation cable

1.2 Cable Description

MulticomCÁ cable possesses high tensile strength and flexibility in compact cable sizes. At the sameÁ time, it provides excellent optical transmission and physical performance.

1.3 Quality

Excellent quality control is achieved through |ã [| [~ • in-house quality & } d [|Á) áÁe • |æ) & by ISO 9001Á | [& • Á [] d [|Á & @ [| [* ^ .

1.4 Reliability

InitialÁ and [} [* product qualification tests for performance and durability are performed to ensure product reliability.

1.5 Reference

MulticomCÁ is Á designed, manufactured and tested according to © Á InternationalÁ ca) ááá • Áe follows:

IEC 60793-1	Optical fiber Part 1: Generic specifications
IEC 60793-2	Optical fiber Part 2: Product specifications
IEC 60794-4	Optical fiber cables-Part 4: Sectional specification-Aerial optical cables along electrical power lines
EIA/TIA 598 B	Color code of fiber optic cables
ITU-T G.650	Definition and test methods for the relevant parameters of single-mode fibers
ITU-T G.652	Characteristics of a single-mode optical fiber cable
ITU-T G.655	Characteristics of a non-zero dispersion-shifted single-mode optical fiber and cable



Technical Specifications:
Self Supporting Aerial Installation Cable
 (According to ITU-T G.652)

Part Numbers:
 12 Count Fiber: MADSS012SM-350
 24 Count Fiber: MADSS024SM-350
 48 Count Fiber: MADSS048SM-350

2. OPTICAL FIBER

- The optical fiber is made of germanium-doped silica. UV curable acrylate material is applied over fiber cladding as a protective coating. The detail data of optical fiber performance is shown in the following table.
- ITU/T G.652 optical fiber uses special technology to successfully control the value of PMD to ensure stability during cabling.

G.652D Fiber in cable

Category	Description	Specifications	
		Before cabling	After cabling
Optical Specifications	Attenuation @1310 nm	≤0.34 dB/km	≤0.36 dB/km
	Attenuation @1383 nm	≤0.34 dB/km	≤0.35 dB/km
	Attenuation @1550 nm	≤0.20 dB/km	≤0.22 dB/km
	Attenuation @1625 nm	≤0.23dB/km	≤0.25 dB/km
	Zero Dispersion Wavelength	1300~1324 nm	
	Zero Dispersion Slope	≤ 0.092 ps/nm ² ·km	
	PMD Link value (M=20cables Q=0.01%) maximum PMD _Q	0.2 ps/√km	
	Cable Cutoff Wavelength (λ _{cc})	≤1260 nm	
	Macro bending Loss (100 turns; Φ50 mm) @1550 nm (100 turns; Φ50 mm) @1625 nm	≤ 0.05 dB ≤ 0.10 dB	
	Mode Field Diameter @1310 nm	9.2±0.4μm	
Dimensional Specifications	Cladding Diameter	125 ±1μm	
	Core/clad concentricity error	≤0.6μm	
	Cladding Non-Circularity	≤1.0%	
Mechanical Specifications	Proof stress	≥0.69Gpa	



Technical Specifications:
Self Supporting Aerial Installation Cable
 (According to ITU-T G.652)

Part Numbers:
 12 Count Fiber: MADSS012SM-350
 24 Count Fiber: MADSS024SM-350
 48 Count Fiber: MADSS048SM-350

3.1 Cable Type: ADSS

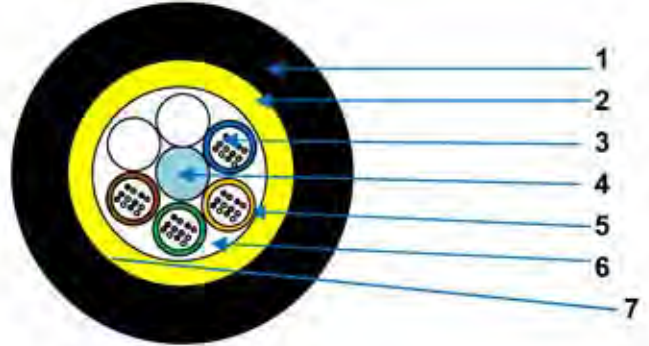

Construction:

1. PE outer sheath
2. Strength member (Aramid yarns)
3. Fiber and jelly
4. Central strength member (FRP)
5. Loose tube
6. Cable jelly
7. Ripcord

Dimension and Properties

Physical	Fiber count	12	24	48
	Fiber No. per tube	6	6	8
	Cable OD	9.9 mm	9.9 mm	9.9mm
	Cable weight	Approx. 98kg/km		
	Operation temperature range	-40 deg C to + 70 deg C		
	Installation temperature range	-10 deg C to + 60 deg C		
	Transport and storage temperature range	-40 deg C to + 70 deg C		
Mechanical	Max. allowable pulling force	2000N		
	Crush resistance	1000 N/10cm		
	Minimal installation bending radius	20 x OD		
	Minimal operation bending radius	10 x OD		

Color code scheme: According to EIA/TIA 598 C

Fiber color	blue	orange	green	brown	gray	white	red	black	/	/	/	/
Tube color	blue	orange	green	brown	gray	white	/	/	/	/	/	/

Note: 1. the nominal outer diameter may vary by $\pm 5\%$. 2. The nominal cable weight may vary by $\pm 10\%$.



Technical Specifications:
Self Supporting Aerial Installation Cable
(According to ITU-T G.652)

Part Numbers:
12 Count Fiber: MADSS012SM-350
24 Count Fiber: MADSS024SM-350
48 Count Fiber: MADSS048SM-350

4. TEST REQUIREMENTS

The following test items are carried out according to the corresponding references:

Routine tests of optical fiber

Mode field diameter	IEC 60793-1-45
Mode field Core/clad concentricity	IEC 60793-1-20
Cladding diameter	IEC 60793-1-20
Cladding non-circularity	IEC 60793-1-20
Coating Diameter	IEC 60793-1-21
Attenuation coefficient	IEC 60793-1-40
Chromatic dispersion	IEC 60793-1-42
Cable cut-off wavelength	IEC 60793-1-44

www.multicominc.com

Multicom, Inc.
Ph: 800-423-2594
Fax: 407-339-0204
Email: multicom@multicominc.com

Multicom ©2015



Technical Specifications:
Self Supporting Aerial Installation Cable
 (According to ITU-T G.652)

Part Numbers:
 12 Count Fiber: MADSS012SM-350
 24 Count Fiber: MADSS024SM-350
 48 Count Fiber: MADSS048SM-350

Technical Specifications

4.1 Tension IEC 60794-1-E1

Sample length	No less than 50 meters
Load	Max. allowable pulling force
	10 minutes
	Fiber strain: ≤0.6%
Test results	Additional attenuation: ≤0.1dB No damage to outer jacket and inner elements

4.2 Crush IEC 60794-1-E3

Plate size	100mm length
Load	Short crush resistance
Duration time	5 minutes
Test number	3
Test results	Additional attenuation: ≤0.1dB No damage to outer jacket and inner elements

4.3 Impact IEC 60794-1-E4

Impact energy	3J
Radius	12.5mm
Impact points	3
Impact number	1
Test result	Additional attenuation: ≤0.1dB No damage to outer jacket and inner elements

4.4 Repeated bending IEC 60794-1-E6

Sample length	1m
Bending radius	20*D
Cycles	30
Test result	Additional attenuation: ≤0.1dB



**Technical Specifications:
Self Supporting Aerial Installation Cable**
(According to ITU-T G.652)

Part Numbers:
12 Count Fiber: MADSS012SM-350
24 Count Fiber: MADSS024SM-350
48 Count Fiber: MADSS048SM-350

4.5 Torsion

IEC 60794-1-E7

Sample length	2m
Angles	±180 degree
cycles	5
Load	150N
Test result	Additional attenuation: ≤0.1dB No damage to outer jacket and inner elements

4.6 Bending

IEC 60794-1-E11

Mandrel diameter	20*D
Turn number	4
Cycles	3
Temperature	20 °C
Test result	Additional attenuation: ≤0.1dB No damage to outer jacket and inner elements

4.7 Temperature cycling

IEC 60794-1-F1

Temperature step	+20°C →-40°C →+70°C →-40°C →+70°C →+20°C
Time per each step	12 hrs
Cycles	2
Test result	Attenuation variation for reference value (the attenuation to be measured before test at +20±3 °C) ≤ 0.10 dB/km

4.8 Water penetration

IEC 60794-1-F5

Water height	1m
Sample length	3m
Duration	24 hrs
Test result	No water leakage at the end of the sample

4.9 Drip

IEC 60794-1-E14

Sample Number	3
Sample length	0.3m
Temperature	70 °C
Duration	24 hrs
Test result	No filling compound shall drip from tubes



Taps - Power Passing

Key Features

- Power Passing - Uninterrupted Service When Faceplate is Removed
- Nickel Plated, Epoxy Sealed Brass "F" Ports
- Powder Coated Housings
- Weather and RFI Gaskets
- Swivel Entry Blocks for Easy Installation of Connectors
- Frequency Range 5-1000 MHz
- Power Rating: 15 amps, 60-90VAC
- 360 Aluminum Alloy Die Cast Housing
- Aerial or Pedestal Mounting
- Printed Circuit Board
- Blocking Capacitors on the "F" Ports for Surge Resistance



Part # - MTSAG-XY

X = Ports 2, 4 or 8

Y = Tap Loss in dB 4, 8, 11, 14, 17, 20, 23, 26, 29, 32, 35

www.multicominc.com

800-423-2594

Multicom, Inc.
1076 Florida Central Parkway
Longwood, FL 32750
Ph: 407-331-7779
Fax: 407-339-0204
Email: multicom@multicominc.com



1 GHz Outdoor Taps with Switch

Product Specifications



FEATURES:

- Glass Epoxy PCB
- 90° Swivel Blocks
- RFI Shielding ≥ 110 dB
- Stainless Steel Hardware
- 360 Die Cast Aluminum Housing
- Heavy Duty Power Passing Choke
- Precision Brass Nickel Plated "F" Ports
- Epoxy Sealed and Drip-lipped "F" Ports
- Power Passing - Uninterrupted Service When Faceplate is Removed
- Heavy-duty Neoprene and Wire Mesh Gaskets
- Strip Gauges on Housing and Heat Shrink Ridges on 5/8-24 Ports

GENERAL SPECIFICATIONS:

Frequency Range:	5 MHz - 1000 MHz
Return Loss All Ports:	5-15 MHz, 18 dB 15-600 MHz, 20 dB 600-750 MHz, 19 dB 750-900 MHz, 18 dB 900-1000 MHz, 17 dB
Tap to Tap Isolation:	5-10 MHz, 20 dB 10-500 MHz, 25 dB 500-750 MHz, 23 dB 750-1000 MHz, 20 dB
Power Passing Rating:	12 Amps (AC/DC), 60-90V

Two Way Taps - MTSAG-2*P			Typical Insertion Loss (dB)								
Part Number	Tap Value (dB)	Color Code	5-10 MHz	10-200 MHz	200-330 MHz	330-450 MHz	450-550 MHz	550-750 MHz	750-860 MHz	860-1000 MHz	Min Isolation Tap to Output
MTSAG-204P	4.0	Pink	Terminating								
MTSAG-208P	8.0	Grey	3.2	3.0	3.2	3.5	3.7	4.1	4.3	4.4	19-25
MTSAG-211P	11.0	Brown	1.9	1.7	2.0	2.0	2.2	2.6	2.8	3.4	19-25
MTSAG-214P	14.0	Yellow	1.2	1.3	1.3	1.4	1.6	1.7	2.2	2.3	21-28
MTSAG-217P	17.0	Purple	1.1	1.0	0.8	1.0	1.1	1.5	1.7	2.0	24-31
MTSAG-220P	20.0	Black	0.8	0.7	0.8	1.0	1.1	1.3	1.6	1.9	25-32
MTSAG-223P	23.0	Orange	0.7	0.5	0.8	0.9	1.0	1.3	1.5	1.8	27-35
MTSAG-226P	26.0	Blue	0.6	0.5	0.7	0.8	0.9	1.2	1.4	1.6	29-35
MTSAG-229P	29.0	White	0.5	0.3	0.5	0.7	0.8	1.2	1.4	1.5	31-43
Four Way Taps - MTSAG-4*P			Typical Insertion Loss (dB)								
Part Number	Tap Value (dB)	Color Code	5-10 MHz	10-200 MHz	200-330 MHz	330-450 MHz	450-550 MHz	550-750 MHz	750-860 MHz	860-1000 MHz	Min Isolation Tap to Output
MTSAG-408P	8.0	Grey	Terminating								
MTSAG-411P	11.0	Brown	3.2	3.0	3.2	3.5	3.7	4.1	4.6	5.0	19-25
MTSAG-414P	14.0	Yellow	2.1	1.7	1.9	2.0	2.2	2.8	3.0	3.4	21-28
MTSAG-417P	17.0	Purple	1.3	1.2	1.3	1.4	1.5	1.8	2.2	2.5	23-31
MTSAG-420P	20.0	Black	1.1	1.0	0.9	1.1	1.2	1.5	1.7	2.1	23-31
MTSAG-423P	23.0	Orange	0.8	0.8	0.9	1.0	1.1	1.4	1.6	1.9	25-33
MTSAG-426P	26.0	Blue	0.7	0.6	0.6	0.8	0.8	1.1	1.4	1.6	29-38
MTSAG-429P	29.0	White	0.7	0.6	0.6	0.8	0.8	1.1	1.4	1.6	31-40
Eight Way Taps - MTSAG-8*P			Typical Insertion Loss (dB)								
Part Number	Tap Value (dB)	Color Code	5-10 MHz	10-200 MHz	200-330 MHz	330-450 MHz	450-550 MHz	550-750 MHz	750-860 MHz	860-1000 MHz	Min Isolation Tap to Output
MTSAG-811P	11.0	Brown	Terminating								
MTSAG-814P	14.0	Yellow	3.7	3.5	3.3	3.5	3.7	4.5	5.0	5.3	19-25
MTSAG-817P	17.0	Purple	2.2	1.8	1.8	2.0	2.2	2.6	3.0	3.5	19-25
MTSAG-820P	20.0	Black	1.3	1.0	1.3	1.4	1.5	1.8	2.2	2.6	21-28
MTSAG-823P	23.0	Orange	0.9	1.1	1.1	1.1	1.2	1.5	1.7	2.1	25-35
MTSAG-826P	26.0	Blue	0.8	0.7	0.8	1.0	1.1	1.4	1.7	1.9	28-38
MTSAG-829P	29.0	White	0.7	0.6	0.7	0.9	1.0	1.3	1.5	1.8	30-40

www.multicominc.com

Multicom, Inc.
Ph: 800-423-2594
Fax: 407-339-0204
Email: multicom@multicominc.com



Line Passives

Splitters, Directional Couplers, Power Inserters

Key Features

- Bandwidth 5-1000 MHz
- Nickel Plated, Epoxy Sealed Brass "F" Ports
- Powder Coated Housings
- Weather and RFI Gaskets
- Swivel Entry Blocks for Easy Installation of Connectors
- 360 Aluminum Alloy Die Cast Housing
- Aerial or Pedestal Mounting
- Printed Circuit Board
- Blocking Capacitors on the "F" Ports for Surge Resistance
- Power Rating: 15 amps, 60-90VAC

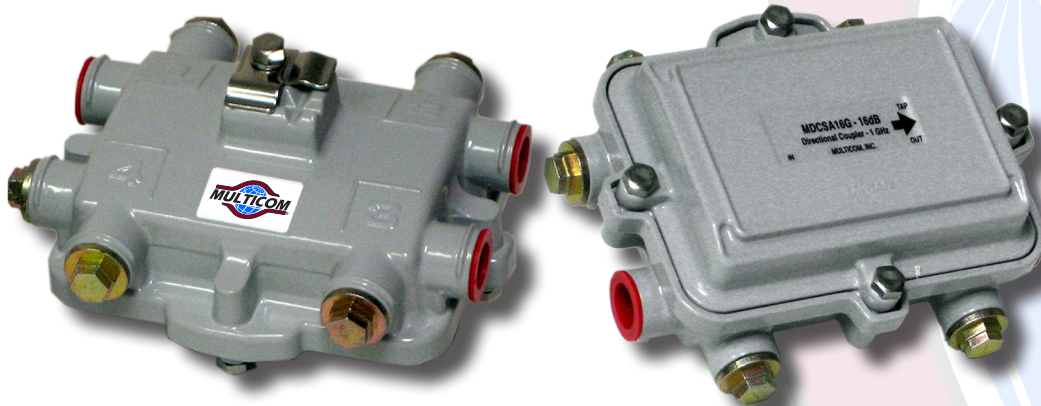

Description

Multicom's new Line Passives are high quality, MSO (Multi-System Operator) approved. The Multicom line of outdoor passives include: Splitters, Directional Couplers and Power Inserters.

MSSA2G **MDCSA8G**
MSSA3BG **MDCSA12G** **MPISAG**
MSSA3UG **MDCSA16G**

www.multicominc.com

Multicom, Inc.
Ph: 800-423-2594 / 407-331-7779

Fax: 407-339-0204

Email: multicom@multicominc.com



Multicom Line Passives

Product Specifications

FEATURES:



- CE Approved
- Fused Output Ports
- SA Compatible Housing
- Stainless Steel Hardware
- Aerial or Pedestal Mounting
- Heavy Duty Power Passing Choke
- 90° Swivel Entry Blocks for Easy Installation
- Glass Epoxy PCB (FR4-G10) with Protective Cover
- Dual Heavy-duty Neoprene and Wire Mesh Gaskets
- Interlocking Tongue & Groove Housing and Faceplate
- 360 Aluminum Alloy Die Cast Housing Sealed and Chromated
- Strip gauges on Housing and Heat Shrink Ridges on 5/8 - 24 Ports

GENERAL SPECIFICATIONS:

Frequency Range:	5 MHz - 1 GHz
Frequency Response (Flatness):	+/- 0.5dB
Hum Modulation at 10 Amps:	70dB (Avg)
Power Passing 60/90VAC (Input):	15 Amps
Power Passing 60/90VAC (Output):	12 Amps
Fuse Rating:	15 Amps
Surge Protection:	C62.411-1991
Response Deviation:	<+/- 0.2dB MHz
RFI Shielding:	> -110dB
Impedance:	75 ohm

Part Number →	MPISAG	MSSA2G	MSSA3BG (balanced)	MSSA3UG (unbalanced)	MDCSA8G	MDCSA12G	MDCSA16G
Description →	Power Inserter	2 Way Splitter	3 Way Splitter	3 Way Splitter	8 dB Directional Coupler	12 dB Directional Coupler	16 dB Directional Coupler
Typical Insertion Loss (dB - Maximum)							
Direction →	RF/AC	In to Out	In to Out	In to Out	In to Out	In to Out	In to Out
5-50 MHz	0.6	4.0	6.4	4.0/7.5	1.8	1.2	0.9
50-100 MHz	0.5	3.8	6.2	3.9/7.4	1.5	1.1	0.8
100-300 MHz	0.6	3.8	6.3	3.9/7.4	1.5	1.2	0.8
300-450 MHz	0.7	3.9	6.3	4.1/7.7	1.6	1.3	0.9
450-600 MHz	0.7	4.2	6.3	4.2/7.9	1.8	1.3	0.9
600-750 MHz	0.7	4.3	6.5	4.5/8.1	2.1	1.4	1.0
750-870 MHz	0.9	4.7	7.1	4.7/8.2	2.4	1.6	1.5
870-900 MHz	1.1	5.1	7.4	5.0/8.6	2.8	1.9	1.8
900-1 GHz	1.2	5.3	7.6	5.2/8.8	3.2	2.4	2.2
Tap Loss (dB - Minimum)							
Direction →	N/A	N/A	N/A	N/A	In to DC	In to DC	In to DC
5-10 MHz	N/A	N/A	N/A	N/A	8.5+/-1.0	12.0+/-1.0	16.0+/-1.0
10-750 MHz	N/A	N/A	N/A	N/A	8.5+/-1.0	12.0+/-1.0	16.0+/-1.0
750-1GHz	N/A	N/A	N/A	N/A	8.5+/-1.0	12.0+/-1.0	16.0+/-1.0
Typical Isolation (dB - Minimum)							
Direction →	AC to RF/AC	Out1/Out2	Out 1/2 to 2/3	Out 1/2 to 2/3	Out to Tap	Out to Tap	Out to Tap
5-50 MHz	70	23	22	23	18	19	22
50-100 MHz	70	24	23	26	25	25	25
100-300 MHz	70	24	24	26	25	25	28
300-450 MHz	68	26	24	26	25	26	28
450-600 MHz	65	25	24	26	25	26	28
600-750 MHz	65	25	23	25	25	26	28
750-870 MHz	63	25	23	25	23	25	27
870-900 MHz	57	23	22	23	21	24	26
900-1 GHz	53	23	22	23	21	24	26
Return Loss (Range Low - High)							
Direction →	RF/AC-RF/AC	In to 1&2	In to 1/2/3	In to 1/2/3	In/Out & Tap	In/Out & Tap	In/Out & Tap
Range	18-21	17-20	17-20	17-20	17-20	17-20	17-20

www.multicominc.com

Multicom, Inc.
 Ph: 800-423-2594
 Fax: 407-339-0204
 Email: multicom@multicominc.com



4 Port Outdoor Optical Node

Key Features

- » Advanced optical AGC circuit design, with the input optical power range of up to $-6 \sim +2\text{dBm}$
- » RF operating bandwidth of 1GHz, with the highest output level $\geq 108\text{dB}\mu\text{V}$ ($+48\text{dBmV}$)
- » The architecture uses an embedded modular design making it easy to maintain, replace, and upgrade

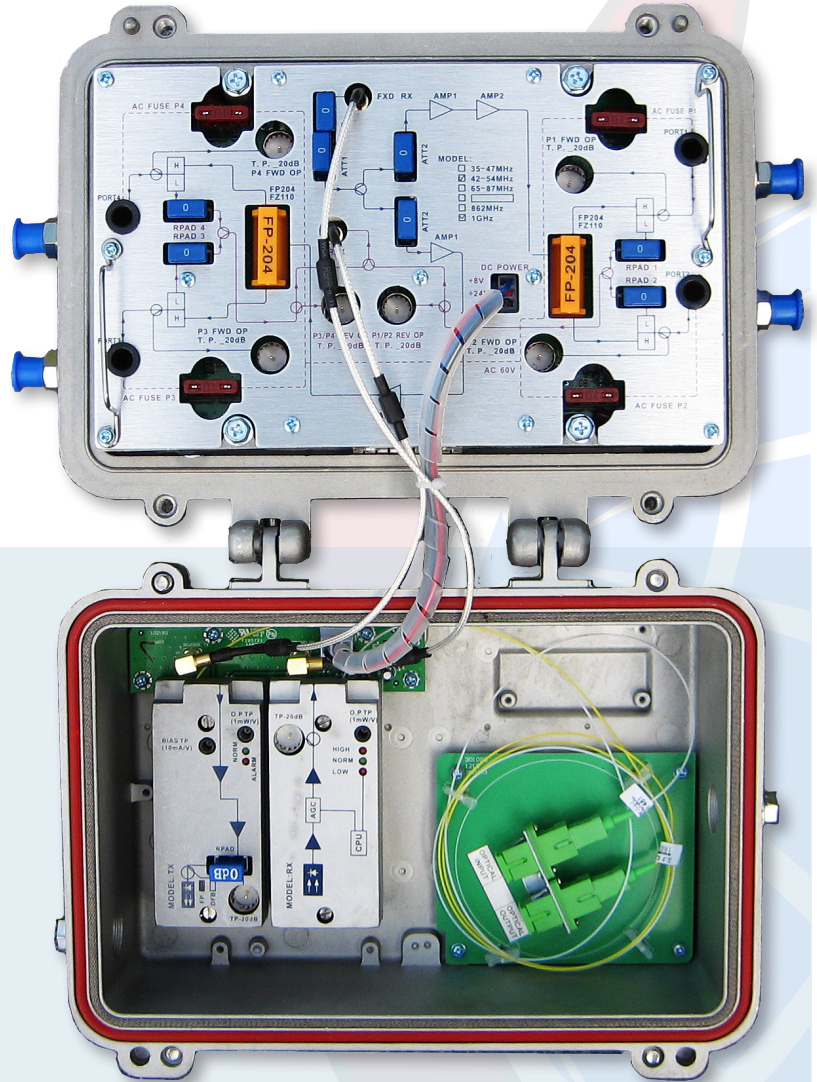

Description

MUL-OFN-V-M-FP-4-M outdoor optical node is bi-directional node specifically developed for HFC broadband networks. It accommodates the FTTH (Fiber to the Home) network topology, while addressing the issues of CATV bidirectional return channel noise and high reliability network security transmission requirements of modern CATV networks.

This outdoor optical node uses a modular architecture allowing fast, easy servicing, a variety of configurations, and easy upgrading. The RF amplifier section and the switching power supply module are in one modular unit in the bottom cover. The top cover can be populated with 1 forward optical receiver module, 1 reverse optical transmitter module and 1 optional Ethernet transponder/ Network Management module.

MUL-OFN-V-M-FP-4-M

- Case Size - S: Small, M: Medium, L: Large
- Number of Ports - 2, 4
- Laser Type - FP, DFB optional upgrade
- Interior Components - M: Modular, F: Fixed

www.multicominc.com

Multicom, Inc.
Ph: 800-423-2594
Fax: 407-339-0204
Email: multicom@multicominc.com



4 Port Outdoor Optical Node

Product Specifications

Item	Unit	Technical Parameter	
Forward Optical Receiver			
Optical Parameters			
Optical Receiving Power	dBm	-6 ~ +2	
Optical Return Loss	dB	> 45	
Optical Receiving Wavelength	nm	1100 ~ 1600	
Optical Connector Type		SC/APC	
Optical Fiber Type		Single Mode	
Link Performance			
C/N	dB	≥ 51	@84ch, Pin= -1dBm, output level 106dBuV, EQ 6dB
C/CTB	dB	≥ 65	
C/CSO	dB	≥ 63	
RF Parameters			
Frequency Range	MHz	54 ~ 1003	
Flatness in Band	dB	± 0.75	
Rated Output Level	dBmV	≥ +46 (≥ 106 dBμV)	
Max Output Level	dBmV	≥ +48 (≥ 108 dBμV) when input optical power -6 ~ +2dBm	
Output Return Loss	dB	≥ 16	
Output Impedance	Ω	75	
Return Optical Transmitter			
Optical Parameters			
Optical Transmit Wavelength	nm	1310 ±10	
Laser Type		FP Laser (DFB Laser is an optional upgrade)	
Optical Output Power	mW	1	
Optical Connector Type		SC/APC	
RF Parameters			
Frequency Range	MHz	5 ~ 42	
Flatness in Band	dB	±0.75	
Input Level	dBmV	+15 ~ +25 (75 ~ 85 dBμV)	
Input Return Loss	dB	≥ 16	
Output Impedance	Ω	75	
NPR Dynamic Range	dB	≥10 (NPR ≥30dB) using the FP laser, ≥15 (NPR ≥30dB) using optional DFB laser	
General Statistics			
Power Voltage	V	AC35 ~ 90V/50-60Hz (insert power at any F-Port)	
Operating Temperature	°C	-30 ~ +70 (-22 ~ +158°F)	
Storage Temperature	°C	-30 ~ +70 (-22 ~ +158°F)	
Relative Humidity	%	Max 95% no condensation	
Consumption	W	≤ 34	
Dimensions	mm	295 (L) x 210 (W) x 150 (H) (11.6in x 8.3in x 6in)	

MUL-OFN-V-M-FP-4-M

Case Size - S: Small, M: Medium, L: Large

Number of Ports - 2, 4

Laser Type - FP, DFB optional upgrade

Interior Components - M: Modular, F: Fixed

www.multicominc.com

Multicom, Inc.
Ph: 800-423-2594 / 407-331-7779

Fax: 407-339-0204

Email: multicom@multicominc.com



Node Service Cable

Key Features

- Multicom Node Service Cable utilizes a specialized 5/8"-24 feed-through adapter, featuring an anti-twist coupling. The anti-twist feature allows the coupling body to be secured to the outdoor housing, without twisting the cable.
- Assemblies come standard in 16.5' (5m) lengths with six fibers and six SC/APC connectors, but can be custom built to specifications with all variation of lengths and connector options available.
- Corning fiber • Loose tube • Armored • Fully water blocked • PE outer jacket

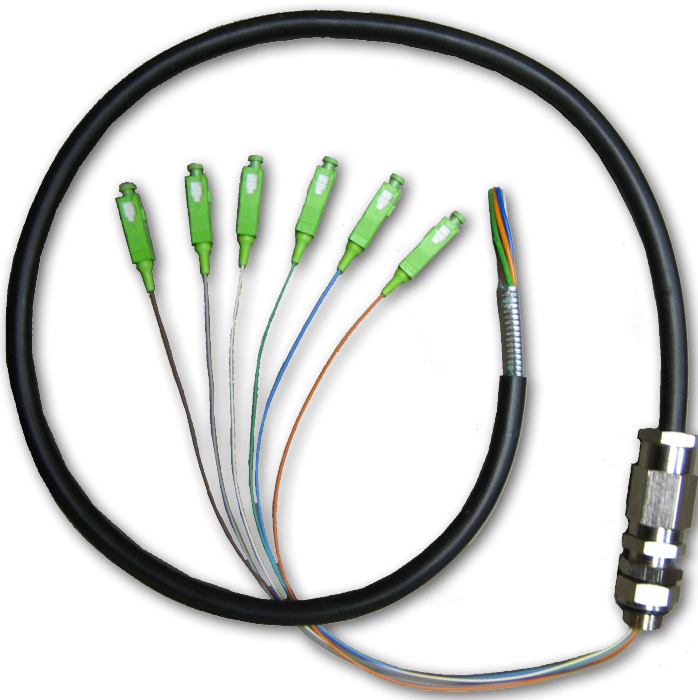

Description

Multicom armored Node Service Cable assemblies are used to link the fiber optic transport cable directly to the fiber optic processing equipment. This connection is critical and requires an environmental seal between the cable and the node housing.

MNSC-xM-xF-xC-xx/xxx

- Connector Type - Ex: SC/APC
- Connectors - x=Number of connectors
- Fibers - x=Number of fibers
- Meters - x=Length in meters

www.multicominc.com

Multicom, Inc.
Ph: 407-331-7779 / 800-423-2594
Fax: 407-339-0204
Email: multicom@multicominc.com



Node Service Cable

Product Specifications

Key Features

- Multicom Node Service Cable utilizes a specialized 5/8"-24 feed-through adapter, featuring an anti-twist coupling. The anti-twist feature allows the coupling body to be secured to the outdoor housing, without twisting the cable.
- Assemblies come standard in 16.5' (5m) lengths with six fibers and six SC/APC connectors, but can be custom built to specifications with all variation of lengths and connector options available.
- Corning fiber • Loose tube • Armored • Fully water blocked • PE outer jacket

Description

Multicom armored Node Service Cable assemblies are used to link the fiber optic transport cable directly to the fiber optic processing equipment. This connection is critical and requires an environmental seal between the cable and the node housing.

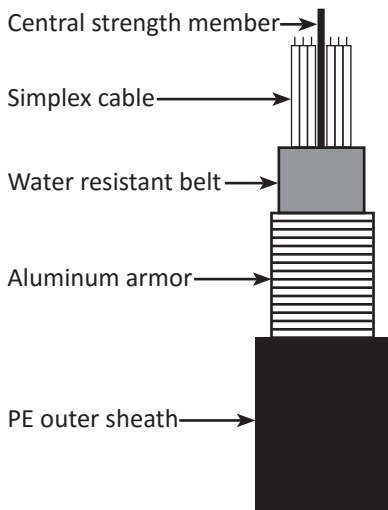

Item	Specification	
Insertion Loss	≤0.30dB	
Return Loss	≥60dB	
Max Attenuation	1310nm ≤0.4dB/km	
	1550nm ≤0.3dB/km	
Temperature	-40°C ~ 80°C	
Tensile Strength (Lbs)	Long term	135
	Short term	300
Compression (Lbs/100mm)	Long term	45
	Short term	225
Bending Radius (Cm)	Dynamic	102
	Static	204

MNSC-xM-xF-xC-xx/xxx

- Connector Type - Ex: SC/APC
- Connectors - x=Number of connectors
- Fibers - x=Number of fibers
- Meters - x=Length in meters

www.multicominc.com

Multicom, Inc.
Ph: 407-331-7779 / 800-423-2594

Fax: 407-339-0204

Email: multicom@multicominc.com

SECTION B

FIBER MANAGEMENT	PAGE
JUMPERs and PIGTAILS	28
<ul style="list-style-type: none"> • SINGLE MODE • MULTIMODE 	
MATING SLEEVES and ATTENUATORS	29
SPLITTERS	30
<ul style="list-style-type: none"> • TUBE • BOX • RACK MOUNT • CASSETTE (LGX) • LGX CHASSIS • WDM (LGX) 	31
SPLICE & PATCH ENCLOSURES	32
<ul style="list-style-type: none"> • RACK MOUNT • ADAPTER PANELS 	33
SFPs	
<ul style="list-style-type: none"> • SFP – See Section F – IT / Data Products • SFP+ - See Section F – IT / Data Products 	94

BACK TO MAIN TABLE OF CONTENTS



Fiber Optic Jumpers and Pigtails

Multicom manufactures a large selection of Singlemode and Multi-Mode fiber optic Jumpers and Pigtails with a selection of industry standard connectors.

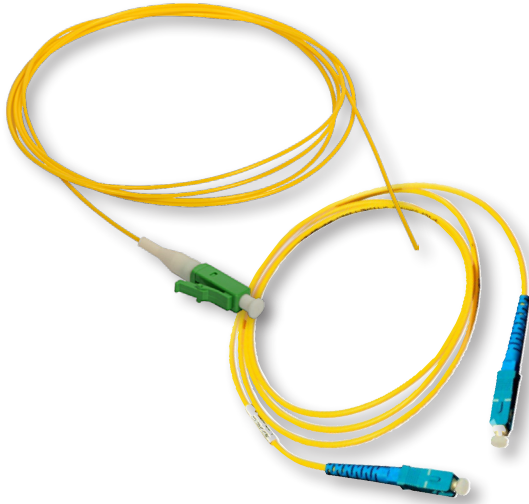

Features:

- » Custom lengths
- » Corning fiber used in all jumpers and pigtails
- » 2mm jacket for more flexibility and capacity in tight spaces
- » Meets all standard panel interfaces
- » All cables serialized and test results are recorded
- » High bandwidth, high tensile strength, small bend radius

Applications:

- » Trunking lines direct to telecommunication closets
- » Fiber patch panel within communication closets
- » Links between electronic equipment and fiber patch panel

CORNING

Don't Settle for Less than the Highest Quality - We Use Only Corning Fiber-Based Fiber Optic Passives

Specifications for FC, ST, and SC Types:

Fiber Type	SM			MM
Contact Mode	PC	UPC	APC	PC
Insertion Loss (dB)	≤0.2	≤0.2	≤0.2	≤0.3
Temperature (°C)	-40 to +80	-40 to +80	-40 to +80	-40 to +80
Repeatability (dB)	≤0.1	≤0.1	≤0.1	≤0.1
Interchange (dB)	≤0.2	≤0.2	≤0.2	≤0.2
Return Loss (dB)	≥45	≥50	≥65	≥35
Cable Diameter	2mm, (0.9mm and 3mm also available)			
Ferrule Material	Zirconia Ceramic			

FOJ-2M-SM-SC/APC-S-SC/APC

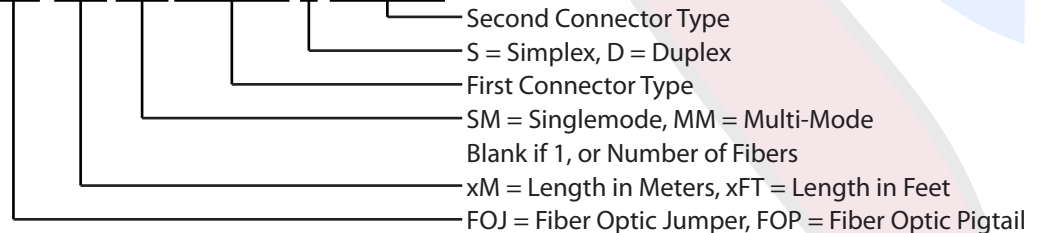

www.multicominc.com

Multicom, Inc.
 1076 Florida Central Parkway
 Longwood, FL 32750
 Ph: 800-423-2594 / 407-331-7779
 Fax: 407-339-0204
 Email: multicom@multicominc.com



Mating Sleeves and Attenuators



Mating Sleeves with high-precision sleeves enable reliable mating of the ferrule diameters, ensuring low insertion and return loss.

Available with all standard connectors.

FOATT-SC/APC-3DB

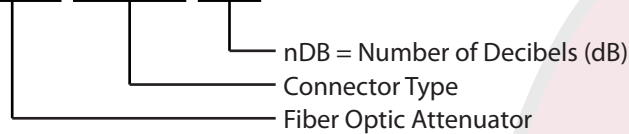

Multicom's line of fiber optic passives also include high quality and cost-effective splitters including tube, box, cassette, and rack-mounted varieties. See our web site for details.

Fixed-value **Attenuators** reduce the signal level without appreciably distorting the waveform.

Available in 1 dB increments and all standard connectors.

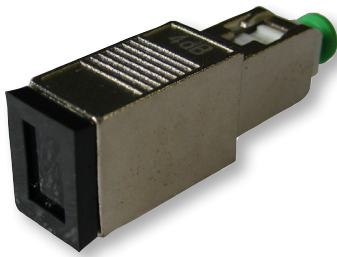

FOMS-SC/APC

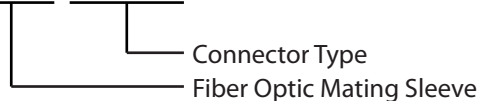

CORNING Don't Settle for Less than the Highest Quality - We Use Only Corning Fiber-Based Fiber Optic Passives

Multicom manufactures a large selection of Singlemode and Multi-Mode fiber optic Jumpers and Pigtaills with a selection of industry standard connectors.

www.multicominc.com

800-423-2594

Multicom, Inc.
1076 Florida Central Parkway
Longwood, FL 32750
Ph: 407-331-7779
Fax: 407-339-0204
Email: multicom@multicominc.com



Fiber Optic Splitters

Multicom's fiber optic splitters are available in a wide range of styles and sizes to split or combine light with minimal loss. All splitters are manufactured using a very simple process that produces reliable, low-cost devices. Splitters can be fabricated in custom fiber lengths and with any type of connector.

Features

- » LGX Compatible
- » Low Insertion Loss
- » Even or Various Splitting Ratios
- » 1x2 through 1x64 Configurations
- » Bidirectional, Compact
- » Environmentally Stable

Applications

- » Long-Haul Tele/Data Communications
- » Fiber Optic Equipment and Systems
- » CATV Systems
- » Local Area Network, PON, and FTTH
- » Fiber Sensors

Multicom manufactures a large variety of splitters:

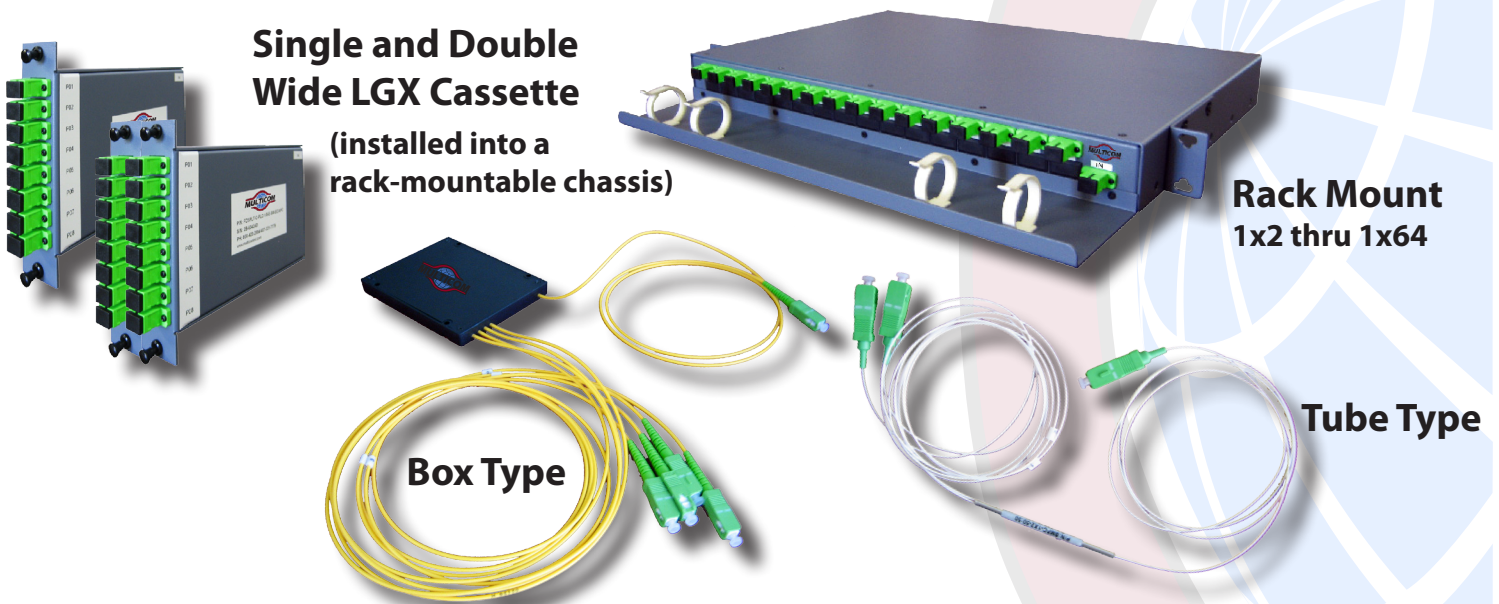

CORNING

**Don't Settle for Less than the Highest Quality -
We Use Only Corning Fiber-Based Fiber Optic Passives**

FOSPL-C-1/8-60/40-SM-SC/APC

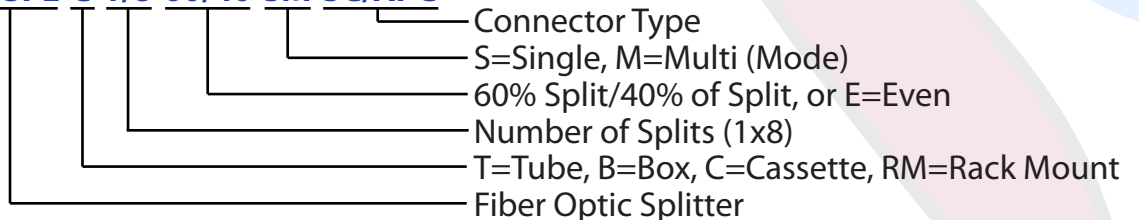

www.multicominc.com

Multicom, Inc.
1076 Florida Central Parkway
Longwood, FL 32750
Ph: 800-423-2594 / 407-331-7779
Fax: 407-339-0204
Email: multicom@multicominc.com



1310/1490/1550nm FTTH PON WDM

Description

Today's FTTH systems demand innovative products for a variety of applications. The Multicom WDM (Wavelength Division Multiplexor), supports 2-way RF services operating with a 1550nm forward path and 1310/1490nm PON Port - over a single fiber - for seamless integration of video, voice, and data services.

General Features

- Standard LGX Form Factor
- Mounts in a Standard LGX Chassis
- Low Insertion Loss
- Ultra-High Isolation
- Wide Operating Temperature Range
- Telcordia GR-1221-Core Compliant
- Front-Located Ports for Easy Access
- All connectors are SC/APC design for optimal power and reliability
- 1550nm Forward Port, 1310/1490nm PON Port, and Common Port



Single Port
WDM



Dual Port
WDM

Applications:

The WDM is ideally suited for use in two-way and high density MDU, CATV, PON and FTTH applications as well as in many other fiber optic-based data, video, and voice networks.

- FTTH Networks
- CATV Networks
- Optical Test Equipment

Available in Single and Dual-Port Design - Either version comes in a one-slot LGX Module

MUL-WDM-PON-S-1310/1490/1550-SC/APC

└ S=Single, D=Dual

└ Connector Type

Cassettes fit in the Multicom Fiber Optic Chassis **PN: MUL-FOCH-CASS**

www.multicominc.com

Multicom, Inc.
Ph: 800-423-2594
Fax: 407-339-0204

Email: multicom@multicominc.com



1 RU Rack Mount - Custom Loaded Patch and Splice Enclosure

Product Specifications

Key Features

- Custom loaded to your specific configuration
- 1.5M Pigtailed included in loaded enclosures
- Splice tray and cable management spools included
- Accepts up to three LGX Adapter Panels
- Hinged front and rear Plexiglass doors
- Side patch and exit ports
- Fully removable sliding-out tray for easy access
- 16 gauge cold rolled steel construction
- Powder coat black finish
- Assorted strain relief and fiber accessories included
- Provides higher patch field density in fewer rack units saving valuable rack space

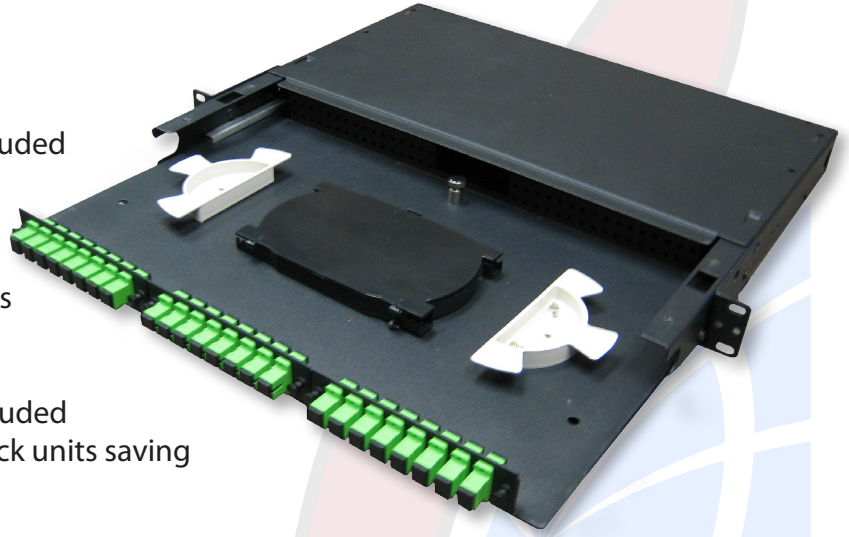

Description

The Multicom 1 RU Patch and Splice Enclosure is designed to accept up to 3 LGX Adapter Panels with the ability to use a full array of connector types. This enclosure offers a flexible solution, enabling the incorporation of a multi-functional chassis that allows easy access during installation or re-work with no disturbance of the existing fiber cable - making this one of the most flexible enclosures on the market.

Characteristics	Specification
Suitable for module type	LGX Adapter Panels
Number of module positions	3 - Can be Simplex/Duplex
Material	16 gauge, cold-rolled steel
Material finish	Black, powder coated
Operating temperature	-40 to 140°F (-40 to 60°C)
Height	1.75" (44.4mm)
Width	17" (432mm)
Depth	14" (356mm)
Net weight	13lbs. (5.9kg)

MUL-RM-8F-PS-SC/APC-S

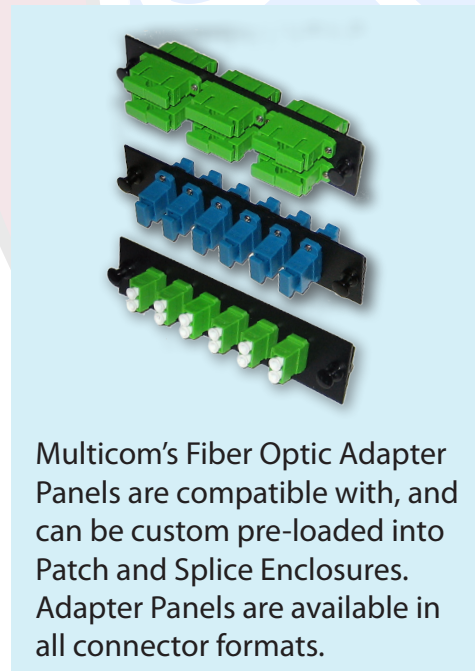
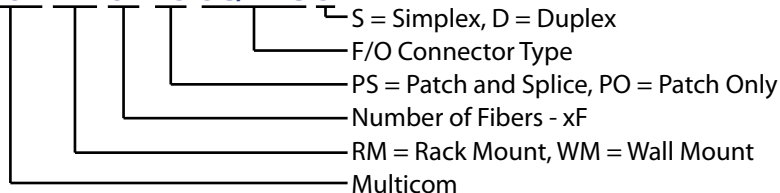

www.multicominc.com

Multicom, Inc.
Ph: 800-423-2594 / 407-331-7779

Fax: 407-339-0204

Email: multicom@multicominc.com



Adapter Panels

Features

- LGX form factor compatible with Multilink, AFL, Wirewerks, FIS, and other rack and wall fiber distribution units
- RoHS Compliant
- Loaded with TIA/EIA-604 FOCIS-3/10 compliant adapters
- Built with ceramic split sleeves to fit specific network requirements
- Quick-release plunger type fastener for fast set up and removal
- 18-gauge cold rolled, electrostatic polyester powder coated steel construction for excellent corrosion resistance and durability
- All panels are pre-loaded for quick deployment

Description

Multicom's Fiber Optic Adapter Panels are compatible with all LGX style rack and wall fiber distribution units. Panels are available in Simplex and Duplex adapter formats.

Dimensions

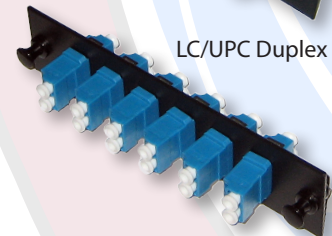
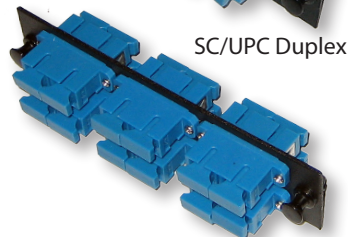
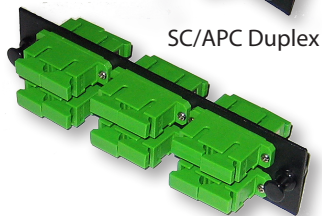
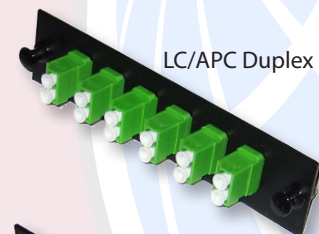
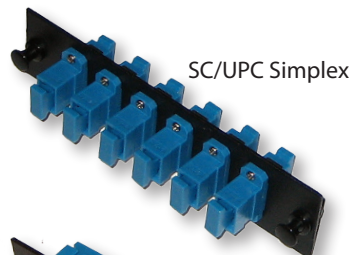
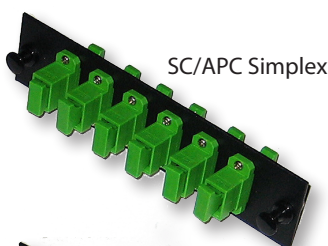
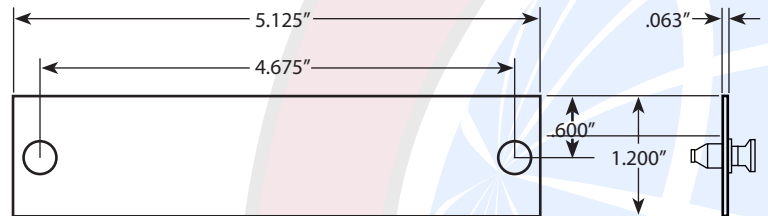

FOAP-6-SM-SC/APC

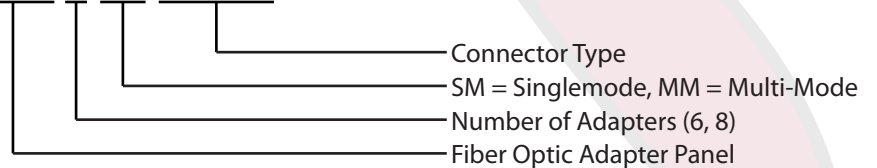

www.multicominc.com

Multicom, Inc.
 1076 Florida Central Parkway
 Longwood, FL 32750
 Ph: 800-423-2594 / 407-331-7779
 Fax: 407-339-0204
 Email: multicom@multicominc.com

SECTION C

FIBER OPTIC HEADEND & TERMINATION

HEADEND	PAGE
TRANSMITTERS	
• 1310nm	36
• 1550nm – 6dB DIRECT MODULATED	38
• 1550nm –10dB DIRECT MODULATED	40
• 1550nm - EXTERNALLY MODULATED	42
EDFA	
• 1550nm	44
• 1550nm HIGH POWER (1 to 8 Ports)	46
• 1550nm 32 PORT HIGH POWER	48
HEADEND RETURN PATH RECEIVER	50
OPTICAL TRANSPORT CHASSIS (OTC) SYSTEM	
• OPTICAL TRANSPORT CHASSIS	52
• 1310nm TRANSMITTER MODULE	53
• 1550nm TRANSMITTER MODULE	55
• RETURN PATH RECEIVER MODULE	57
• EDFA MODULE	59
CHANNEL ELIMINATION FILTER	61
IRH-PANEL	63
RACK MOUNT MULTISWITCH CHASSIS & KIT	64

BACK TO MAIN TABLE OF CONTENTS

SECTION C - Continued

FIBER OPTIC HEADEND & TERMINATION

TERMINATION	PAGE
• TRANSMIT & RECEIVE HIGH POWER NODE	65
• TRANSMIT & RECEIVE NODE	67
• RECEIVE ONLY NODE	69
• RFOG MICRO-NODE	70

BACK TO MAIN TABLE OF CONTENTS



1310nm Intelligent Direct Modulated Optical Transmitter

Key Features

- » High linearity, optically isolated, distributed AM feedback ORTEL DFB laser
- » Transmits NTSC, PAL, ATSC, and related digital information for CATV and/or telephony applications
- » Available in 7.7, 10, 12, 14 and 14.9 dBm output power
- » 47-1003MHz RF input bandwidth
- » Front panel RF test point
- » Microprocessor-controlled diagnostics, front panel LCD display and controls
- » Automatic Gain Control (AGC) and Manual Gain Control (MGC) override
- » Integrated SNMP network interface
- » Dual hot-pluggable redundant power supplies



Description

The MUL-1310TX-V-1-X intelligent directly modulated optical transmitter is mainly used in 1310nm optical fiber transmission systems. It uses an ORTEL DFB laser with an optical output power of 7.7, 10, 12, 14 and 14.9 dBm, and advanced intelligent electronic predistortion compensation technology.

This intelligent directly modulated optical transmitter is one of the most important components to build a CATV-HFC network. It is mainly used to transmit analog video, digital television signal, telephone voice signal and data (or compressed data) signal. This Multicom product provides a high quality low cost transmitter solution for a 1310nm optical fiber CATV system.

MUL-1310TX-V-1-10

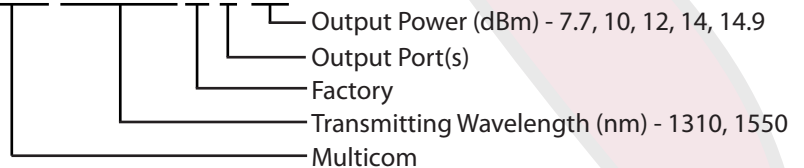

www.multicominc.com

Multicom, Inc.
Ph: 800-423-2594
Fax: 407-339-0204
Email: multicom@multicominc.com



1310nm Intelligent Direct Modulated Optical Transmitter

Product Specifications

Description

The MUL-1310TX-V-1-X intelligent directly modulated optical transmitter is mainly used in 1310nm optical fiber transmission systems. It uses an ORTEL DFB laser with an optical output power of 7.7, 10, 12, 14 and 14.9 dBm, and advanced intelligent electronic predistortion compensation technology.

This intelligent directly modulated optical transmitter is one of the most important components to build a CATV-HFC network. It is mainly used to transmit analog video, digital television signal, telephone voice signal and data (or compressed data) signal. This Multicom product provides a high quality low cost transmitter solution for a 1310nm optical fiber CATV system.

Technical Specifications

Item	Unit	Technical Parameters
Optical output power	dBm	7.7, 10, 12, 14, 14.9
Optical wavelength	nm	1310 ± 20
Laser type		ORTEL DFB laser
Optical modulation mode		Direct optical intensity modulation
Optical connector type		SC/APC
Frequency range	MHz	47-750 / 862 / 1003 (depending on selected channel load)
RF input level	dBμV	72 - 88 (+12 to +28dBmV)
Flatness in band	dB	± 0.75
RF input impedance	Ω	75
Input return loss	dB	≥ 16 (47 - 550MHz); ≥ 14 (550 - 1003MHz)
C/CSO	dB	≥ 60
C/CTB	dB	≥ 65
C/N	dB	≥ 51
AGC control range	dB	± 5
MGC control range	dB	0 - 20
Power supply voltage	V	AC 110V - 250V (50/60Hz) (redundant power)
Consumption	W	30
Operating temperature	°C	0 - +45 (+32 - +113°F)
Storage temperature	°C	-20 - +65 (-4 - +150°F)
Relative humidity	%	Max 95% no condensation
Dimensions	mm	483 (W) x 380 (D) x 44 (H); (19in W x 15in D x 1.75in H)

MUL-1310TX-V-1-10

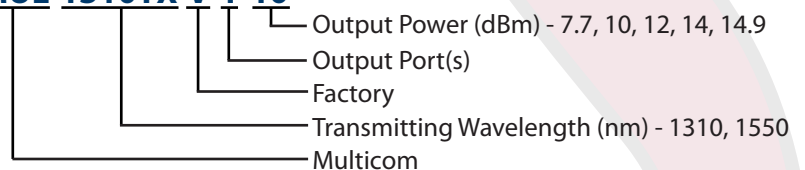

www.multicominc.com

Multicom, Inc.
Ph: 800-423-2594
Fax: 407-339-0204

Email: multicom@multicominc.com



1550nm 6dB Intelligent Direct Modulated Optical Transmitter

Key Features

- » High linearity, optically isolated, distributed AM feedback ORTEL DFB laser with an optical output power of 6dBm
- » Transmits NTSC, PAL, ATSC, and related digital information for CATV and/or telephony applications
- » 47-1003 MHz RF input bandwidth
- » Front panel RF test point
- » Microprocessor-controlled diagnostics, front panel LCD display and controls
- » Automatic Gain Control (AGC) and Manual Gain Control (MGC) override
- » Integrated SNMP network interface
- » Dual hot-pluggable redundant power supplies



Description

The MUL-1550TX-V-1-6 intelligent directly modulated optical transmitter is mainly used in 1550nm optical fiber transmission systems. It uses an ORTEL DFB laser with an optical output power of 6dBm, and advanced intelligent electronic predistortion compensation technology.

This intelligent directly modulated optical transmitter is one of the most important components to build a CATV-HFC network. It is mainly used to transmit analog video, digital television signal, telephone voice signal and data (or compressed data) signal. This Multicom product provides a high quality low cost transmitter solution for a 1550nm optical fiber CATV system.

MUL-1550TX-V-1-6

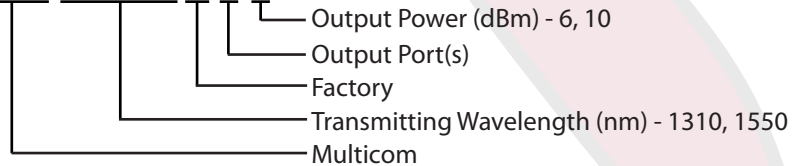

www.multicominc.com

Multicom, Inc.
Ph: 800-423-2594
Fax: 407-339-0204
Email: multicom@multicominc.com



1550nm 6dB Intelligent Direct Modulated Optical Transmitter

Product Specifications

Description

The MUL-1550TX-V-1-6 intelligent directly modulated optical transmitter is mainly used in 1550nm optical fiber transmission systems. It uses an ORTEL DFB laser with an optical output power of 6dBm, and advanced intelligent electronic predistortion compensation technology.

This intelligent directly modulated optical transmitter is one of the most important components to build a CATV-HFC network. It is mainly used to transmit analog video, digital television signal, telephone voice signal and data (or compressed data) signal. This Multicom product provides a high quality low cost transmitter solution for a 1550nm optical fiber CATV system.

Technical Specifications

Item	Unit	Technical Parameters
Optical output power	dBm	6
Optical wavelength	nm	1550 ± 10
Laser type		ORTEL DFB laser
Optical modulation mode		Direct optical intensity modulation
Optical connector type		SC/APC
Frequency range	MHz	47-862 / 1003 (depending on selected channel load)
RF input level	dBμV	72 - 88 (+12 to +28dBmV)
Flatness in band	dB	± 0.75
RF input impedance	Ω	75
Input return loss	dB	≥ 16 (47 - 550MHz); ≥ 14 (550 - 1003MHz)
C/CSO	dB	≥ 60
C/CTB	dB	≥ 65
C/N	dB	≥ 51
AGC control range	dB	± 5
MGC control range	dB	0 - 10
Power supply voltage	V	AC 110V - 250V (50/60Hz) (redundant power)
Consumption	W	30
Operating temperature	°C	0 - +45 (+32 - +113°F)
Storage temperature	°C	-20 - +65 (-4 - +150°F)
Relative humidity	%	Max 95% no condensation
Dimensions	mm	483 (W) x 380 (D) x 44 (H); (19in W x 15in D x 1.75in H)

MUL-1550TX-V-1-6

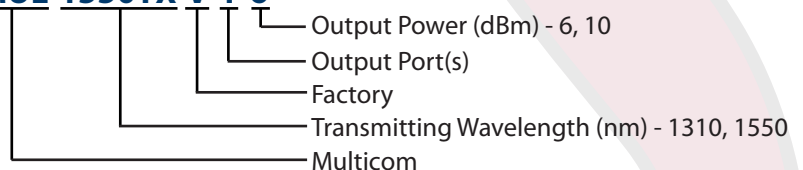

www.multicominc.com

Multicom, Inc.

Ph: 800-423-2594 / 407-331-7779

Fax: 407-339-0204

Email: multicom@multicominc.com



1550nm 10dB Intelligent Direct Modulated Optical Transmitter

Key Features

- » High linearity, optically isolated, distributed AM feedback ORTEL DFB laser with an optical output power of 10dBm
- » Transmits NTSC, PAL, ATSC, and related digital information for CATV and/or telephony applications
- » 47-1003 MHz RF input bandwidth
- » Front panel RF test point
- » Microprocessor-controlled diagnostics, front panel LCD display and controls
- » Automatic Gain Control (AGC) and Manual Gain Control (MGC) override
- » Integrated SNMP network interface
- » Dual hot-pluggable redundant power supplies



Description

The MUL-1550TX-V-1-10 intelligent directly modulated optical transmitter is mainly used in 1550nm optical fiber transmission systems. It uses an ORTEL DFB laser with an optical output power of 10dBm, and advanced intelligent electronic predistortion compensation technology (adjustable up to 50km in 1km steps).

This intelligent directly modulated optical transmitter is one of the most important components to build a CATV-HFC network. It is mainly used to transmit analog video, digital television signal, telephone voice signal and data (or compressed data) signal. This Multicom product provides a high quality low cost transmitter solution for a 1550nm optical fiber CATV system.

MUL-1550TX-V-1-10

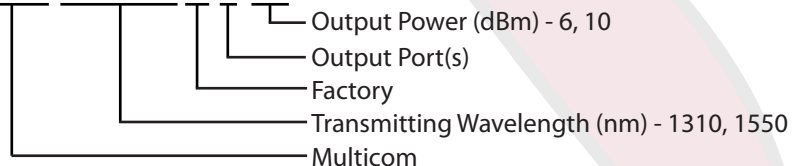

www.multicominc.com

Multicom, Inc.
Ph: 800-423-2594
Fax: 407-339-0204
Email: multicom@multicominc.com



1550nm 10dB Intelligent Direct Modulated Optical Transmitter

Product Specifications

Description

The MUL-1550TX-V-1-10 intelligent directly modulated optical transmitter is mainly used in 1550nm optical fiber transmission systems. It uses an ORTEL DFB laser with an optical output power of 10dBm, and advanced intelligent electronic predistortion compensation technology (adjustable up to 50km in 1km steps).

This intelligent directly modulated optical transmitter is one of the most important components to build a CATV-HFC network. It is mainly used to transmit analog video, digital television signal, telephone voice signal and data (or compressed data) signal. This Multicom product provides a high quality low cost transmitter solution for a 1550nm optical fiber CATV system.

Technical Specifications

Item	Unit	Technical Parameters
Optical output power	dBm	10
Optical wavelength	nm	1550 ± 10
Dispersion compensation distance	Km	≤ 50
Laser type		ORTEL DFB laser
Optical modulation mode		Direct optical intensity modulation
Optical connector type		SC/APC
Frequency range	MHz	47-862 / 1003 (depending on selected channel load)
RF input level	dBmV	+15 to +25 (dBμV 75 - 85)
Flatness in band	dB	± 0.75
RF input impedance	Ω	75
Input return loss	dB	≥ 16
AGC control range	dB	± 5
MGC control range	dB	0 - 20
Power supply voltage	V	AC 110V - 250V (50/60Hz) (redundant power)
Consumption	W	30
Operating temperature	°C	0 - +45 (+32 - +113°F)
Storage temperature	°C	-20 - +65 (-4 - +150°F)
Relative humidity	%	Max 95% no condensation
Dimensions	mm	483 (W) x 380 (D) x 44 (H); (19in W x 15in D x 1.75in H)

MUL-1550TX-V-1-10

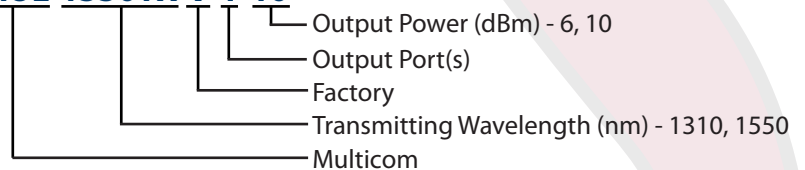

www.multicominc.com

Multicom, Inc.
Ph: 800-423-2594 / 407-331-7779

Fax: 407-339-0204

Email: multicom@multicominc.com



1550nm Externally Modulated Optical Transmitter

Key Features

- » Two high linearity, optically isolated, distributed AM feedback ORTEL DFB lasers capable of transmitting 7, 8, 9 and 10 dBm each
- » Transmits NTSC, PAL, ATSC, and related digital information for CATV and/or telephony applications
- » 47-1003 MHz RF input bandwidth
- » Front panel RF test point
- » Microprocessor-controlled diagnostics, front panel LCD display and controls
- » Automatic Gain Control (AGC) and Manual Gain Control (MGC) override
- » Integrated SNMP network interface
- » Dual hot-pluggable redundant power supplies



Description

The Multicom MUL-1550TXEM-V-2 Externally Modulated Optical Transmitter is a state-of-the-art high-performance fiber optic transmitter specially developed for CATV signal distribution in HFC networks, and the long-distance transmission of cable phone and cable data. Optimized for a variety network applications, it is packaged in a convenient 1 RU housing. This two-ORTEL DFB laser transmitter couples the optical output powers of 7, 8, 9 and 10dBm each, with low optical linewidth resulting in unmatched performance.

The optical modulator, combined with proprietary predistortion circuitry, provides advanced features such as built-in field adjustable SBS control and electronic dispersion compensation allowing these transmitters to be quickly optimized in the field for any link or application without the need to procure specifically tuned transmitters. This affords the system designer a level of flexibility previously unknown in the CATV market place.

MUL-1550TXEM-V-2-10

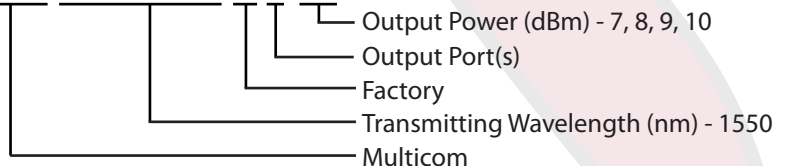

www.multicominc.com

Multicom, Inc.
Ph: 800-423-2594
Fax: 407-339-0204
Email: multicom@multicominc.com



1550nm Externally Modulated Optical Transmitter

Product Specifications

Description

The Multicom MUL-1550TXEM-V-2 Externally Modulated Optical Transmitter is a state-of-the-art high-performance fiber optic transmitter specially developed for CATV signal distribution in HFC networks, and the long-distance transmission of cable phone and cable data. Optimized for a variety network applications, it is packaged in a convenient 1 RU housing. This two-ORTEL DFB laser transmitter couples the optical output powers of 7, 8, 9 and 10dBm each, with low optical linewidth resulting in unmatched performance.

Technical Specifications

Item	Unit	Technical Parameters
Optical wavelength	nm	1545 ~ 1560
Side-mode suppression ratio	dB	> 30
Laser type		ORTEL DFB
Relative intensity noise	dB/Hz	< -160
Wavelength adjustment range	GHz	± 50
Optical power	dBm	2*7, 2*8, 2*9, 2*10
SBS threshold value	dBm	+13 ~ +19 (continuously adjustable)
Laser linewidth	MHz	0.3
Optical connector		SC/APC
RF range	MHz	47 ~ 1003
RF flatness	dB	± 0.75
RF return loss	dB	> 16
RF input impedance	Ω	75
RF input connector type		F type
Rated input level	dBmV	+20 (dBμV 80) (+20dBmV)
Input level range	dBmV	+18 to +36 (dBμV 78 ~ 96) (AGC mode, modulating signal)
AGC control range	dB	-3 ~ +3
MGC adjustable range	dB	0 ~ 15
Power source specification	V	110V ~ 240VAC (redundant power)
Consumption	W	≤ 60
Operating temperature	°C	-5 - +45 (+20 - +113°F)
Storage temperature	°C	-30 - +70 (-20 - +150°F)
Relative humidity	%	Max 95% no condensation
Dimensions	mm	483 (W) x 455 (D) x 44 (H); (19in W x 18in D x 1.75in H)
Total weight	Kg	5.5 (12lbs.)

MUL-1550TXEM-V-2-10

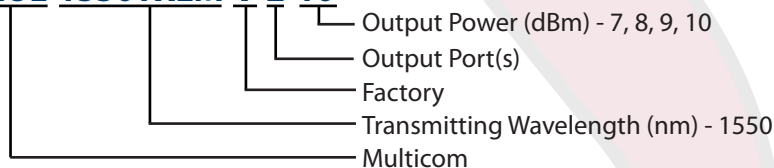

www.multicominc.com

Multicom, Inc.
Ph: 800-423-2594 407-331-7779
Fax: 407-339-0204
Email: multicom@multicominc.com



1550nm EDFA

Key Features

- » Automatic control of the output optical power
- » Output optical power attenuation is adjustable
- » High-performance erbium doped fiber amplifier, high efficiency energy conversion
- » Advanced 32 bit processor, with automatic monitoring circuitry. Accurately monitors and controls the optical output power and various parameters of the pump laser, ensures stable optical output power and can effectively extend the working life of the pump laser.
- » Front panel LCD display shows all status parameters and provides ability to set parameters on the EDFA
- » 1RU standard 19" rackmount cabinet, equipped with standard IEEE802.3 10Base-T Ethernet interface and RS232 interface, for network management monitoring and control console.



Description

The Multicom 1550nm Erbium Doped Fiber Amplifier (EDFA) is a low noise 1550nm optical amplifier, designed using advanced optical principles. The hot pluggable, redundant power EDFA is designed to amplify 1550nm optical signals to increase the optical transmission distance over fiber, and can be used in conjunction with the Multicom 1550nm optical transmitters.

The MUL-EDFA-V-1 is flexible enough to perform in numerous upstream and downstream applications, including supertrunk transmission, hub interconnects and 1310/1550nm overlays. All internal laser parameters and monitoring functions are under microprocessor control. The front panel LCD displays status information related to laser operation, temperatures, laser pump status, comprehensive alarm information, as well as SNMP configuration. The units are packaged in slim 1.75-inch high (1RU), 19-inch aluminum rack-mounted enclosures.

MUL-EDFA-V-1-18

- Output Power (dBm) - 18, 24
- Output Port(s)
- Factory
- Erbium Doped Fiber Amplifier
- Multicom

www.multicominc.com

Multicom, Inc.
Ph: 800-423-2594 / 407-331-7779

Fax: 407-339-0204

Email: multicom@multicominc.com



1550nm EDFA

Product Specifications

Description

The Multicom 1550nm Erbium Doped Fiber Amplifier (EDFA) is a low noise 1550nm optical amplifier, designed using advanced optical principles. The hot pluggable, redundant power EDFA is designed to amplify 1550nm optical signals to increase the optical transmission distance over fiber, and can be used in conjunction with the Multicom 1550nm optical transmitters.

Technical Specifications

Item	Unit	Technical Parameter	Notes
Operating bandwidth	nm	1535 - 1565	
Optical input power range	dBm	-5 ~ +10	
Optical output power	dBm	18 or 24	
Output power stability	dBm	± 0.2	
Noise figure	dB	≤ 5.0	Optical input power 0dBm
Return loss - Input port	dB	≥ 45	
Return loss - Output port	dB	≥ 45	
Optical connector type		SC/APC	
Power supply voltage	V	110V - 240VAC (50/60 Hz)	Hot pluggable, redundant power
Power consumption	W	< 30	
Operating temperature range	°C	-5 - +55	23 - 130°F
Storage temperature range	°C	-30 - +70	-22 - 158°F
Max operating/storage relative humidity	%	95	No condensation
Dimensions	mm	483 (L) x 340 (W) x 44 (H)	19in x 13.4in x 1.75in

MUL-EDFA-V-1-18

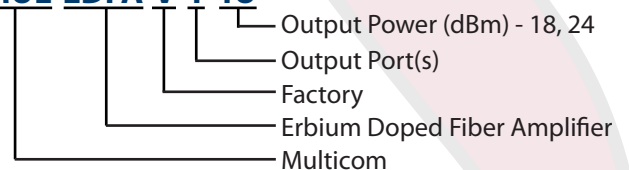

www.multicominc.com

Multicom, Inc.

Ph: 800-423-2594 / 407-331-7779

Fax: 407-339-0204

Email: multicom@multicominc.com



High Power 1550nm EDFA

Key Features

- » Uses Er Yb co-doped double-clad fiber technology
- » Output ports: 4 (1 to 8, optionally)
- » Optional: Internal WDM ports configurations for GPON
- » Optical output power from 19 to 26dBm
- » Low noise figure: <5dB when input is 0dBm
- » Advanced 32 bit processor, with automatic monitoring circuit. Accurately monitors and controls the optical output power and various parameters of the laser, ensures stable optical output power and can effectively extend the working life of the laser.
- » Front panel LCD Status Display shows all status parameters and provides ability to set parameters
- » 1RU standard 19" rackmount cabinet, equipped with standard IEEE802.3 10Base-T Ethernet interface and RS232 interface, for network management monitoring and control console



Description

The Multicom High Power 1550nm Erbium Doped EDFA is a low noise 1550nm optical amplifier designed to amplify 1550nm optical signals to increase the optical transmission distance over fiber, and can be used in conjunction with the Multicom 1550nm optical transmitters.

Equipped with up to eight output ports, and with low noise and high linearity, this High Power EDFA can be used in the transmission of video, voice and data signals making it the ideal optical amplification solutions for long links, redundant rings, blast and split, and other applications. It offers a flexible and low-cost solution for CATV large area coverage of metropolitan and medium-sized cities.

MUL-EDFA-V-4-26

- Output Power per Port (dBm) - 19-26
- Output Port(s) - 1 to 8
- Factory
- Erbium Doped Fiber Amplifier
- Multicom

www.multicominc.com

Multicom, Inc.
Ph: 800-423-2594 / 407-331-7779

Fax: 407-339-0204

Email: multicom@multicominc.com



High Power 1550nm EDFA

Product Specifications

Description

The Multicom High Power 1550nm Erbium Doped EDFA is a low noise 1550nm optical amplifier designed to amplify 1550nm optical signals to increase the optical transmission distance over fiber, and can be used in conjunction with the Multicom 1550nm optical transmitters.

Equipped with up to eight output ports, and with low noise and high linearity, this High Power EDFA can be used in the transmission of video, voice and data signals making it the ideal optical amplification solutions for long links, redundant rings, blast and split, and other applications. It offers a flexible and low-cost solution for CATV large area coverage of metropolitan and medium-sized cities.

Technical Specifications

Item	Unit	Technical Parameter	Notes
Operating bandwidth	nm	1545 ~ 1565	
Optical input power range	dBm	-5 ~ +10	
Optical output power	dBm	19 - 26	
Maximum optical output power	dBm	26	
Output power stability	dBm	±0.5	
Noise figure	dB	≤5.0	Optical input power 0dBm, λ=1550nm
Return loss - Input port	dB	≥ 45	
Return loss - Output port	dB	≥ 45	
Optical connector type		SC/APC	
C/N	dB	≥ 50	Test conditions according to GT/T 184-2002
C/CTB	dB	≥ 63	
C/CSO	dB	≥ 63	
Power supply voltage	V	110V - 240VAC (50/60 Hz)	50 Hz
Operating temperature range	°C	-10 - +42	14 - 108°F
Max operating/storage relative humidity	%	95	No condensation
Storage temperature range	°C	-30 ~ +70	-22 - 158°F
Dimensions	mm	483 (L) x 475 (W) x 44 (H)	19in L x 18.7in W x 1.75in H

MUL-EDFA-V-4-26

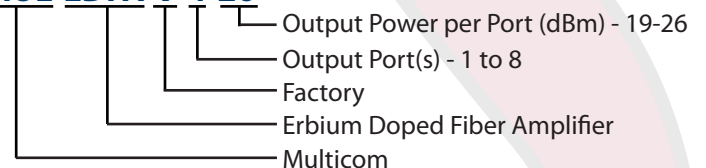

www.multicominc.com

Multicom, Inc.
Ph: 800-423-2594 / 407-331-7779

Fax: 407-339-0204

Email: multicom@multicominc.com



32 Port High Power 1550nm EDFA

Key Features

- » Uses Er Yb co-doped double-clad fiber technology
- » Output ports: 32
- » Optical output power up to 37dBm and 20 dBm optical output over all 32 ports
- » Low noise figure: <5dB when input is 0dBm
- » Advanced 32 bit processor, with automatic monitoring circuit. Accurately monitors and controls the optical output power and various parameters of the laser, ensures stable optical output power and can effectively extend the working life of the laser.
- » Front panel LCD Status Display shows all status parameters and provides ability to set parameters on the EDFA
- » 2RU standard 19" rackmount cabinet, equipped with standard IEEE802.3 10Base-T Ethernet interface and RS232 interface, for network management monitoring and control console



Description

The Multicom 32 Port High Power 1550nm Erbium Doped EDFA is a low noise 1550nm optical amplifier designed to amplify 1550nm optical signals to increase the optical transmission distance over fiber, and can be used in conjunction with the Multicom 1550nm optical transmitters.

Equipped with up to 32 output ports, and with low noise and high linearity, this High Power EDFA can be used in the transmission of video, voice and data signals making it the ideal optical amplification solutions for long links, redundant rings, blast and split, and other applications. It offers a flexible and low-cost solution for CATV large area coverage of metropolitan and medium-sized cities.

MUL-EDFA-V-XX-XX



www.multicominc.com

Multicom, Inc.
Ph: 800-423-2594
Fax: 407-339-0204
Email: multicom@multicominc.com



32 Port High Power 1550nm EDFA

Product Specifications

Technical Specifications

Item	Unit	Technical Parameter	Notes
Operating bandwidth	nm	1545 - 1565	
Optical input power range	dBm	-5 - +10	
Optical power per each port	dBm	20	32 optical output ports
Maximum optical output power	dBm	37 (optional)	Depends on power option purchased
Output power stability	dBm	±0.5	
Noise figure	dB	≤5.0	Optical input power 0dBm, λ=1550nm
Return loss - Input port	dB	≥ 45	
Return loss - Output port	dB	≥ 45	
Optical connector type		SC/APC	
Power supply voltage	V	110V - 240VAC (50/60 Hz)	Hot pluggable, redundant power
Operating temperature range	°C	-10 - +42	14 - 108°F
Max operating/storage relative humidity	%	95	No condensation
Storage temperature range	°C	-30 ~ +70	-22 - 158°F
Dimensions	mm	483 (L) x 440 (W) x 88 (H)	19in L x 17.3in W x 3.5in H

Model # and Power

Model #	Total Output Power (dBm)	Output Ports	Output Power per Port (dBm)
MUL-EDFA-V-16-29	29	16	15
MUL-EDFA-V-16-30	30	16	16
MUL-EDFA-V-16-31	31	16	17
MUL-EDFA-V-16-32	32	16	18
MUL-EDFA-V-16-33	33	16	19
MUL-EDFA-V-16-34	34	16	20
MUL-EDFA-V-16-35	35	16	21
MUL-EDFA-V-16-36	36	16	22
MUL-EDFA-V-32-33	33	32	16
MUL-EDFA-V-32-34	34	32	17
MUL-EDFA-V-32-35	35	32	18
MUL-EDFA-V-32-36	36	32	19
MUL-EDFA-V-32-37	37	32	20

MUL-EDFA-V-XX-XX

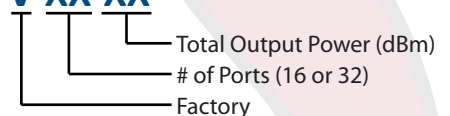

www.multicominc.com

Multicom, Inc.
 Ph: 800-423-2594 / 407-331-7779
 Fax: 407-339-0204
 Email: multicom@multicominc.com



Optical Return Path Receiver

Key Features

- » Wide optical Input Range 1200 - 1620nm
- » +25dBmV typical RF output for each of the 4 ports
- » 5 - 200MHz return bandwidth
- » Four receivers in 1RU unit
- » Wide optical input range and low noise design allows error free detection down to -9dBm
- » Configuration and status monitoring on the easy-to-view backlit front panel display
- » Housing temperature is displayed, monitored, and controlled by the micro-processor
- » Optional factory installed SNMP

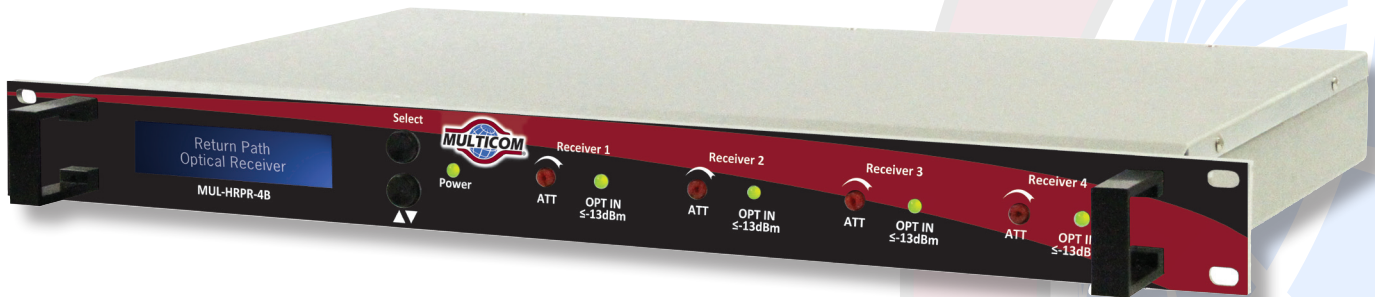

Description

The Multicom MUL-HRPR-4B Optical Return Path Receiver is ideally suited for use in optical headends in HFC and FTTH and many other fiber optic-based data, video, and voice networks, including Broadband Stimulus and FCC National Broadband projects and applications, and provides a cost effective solution.

The MUL-HRPR-4B's state-of-the-art features include an industry-leading 4 port, typical +25dBmV individually adjustable RF outputs, 5 - 200MHz return bandwidth, wide optical input range down to -9dBm, and a unique backlit front panel control display - all in a temperature-controlled, 1 RU rack-mount chassis.

MUL-HRPR-4B

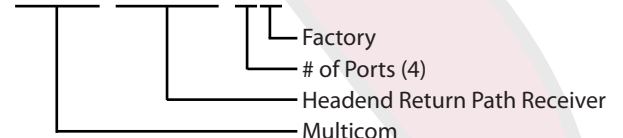

www.multicominc.com

Multicom, Inc.
Ph: 800-423-2594
Fax: 407-339-0204
Email: multicom@multicominc.com



Optical Return Path Receiver

Product Specifications

Description

The Multicom MUL-HRPR-4B Optical Return Path Receiver is ideally suited for use in optical headends in HFC and FTTH and many other fiber optic-based data, video, and voice networks, including Broadband Stimulus and FCC National Broadband projects and applications, and provides a cost effective solution.

The MUL-HRPR-4B's state-of-the-art features include an industry-leading 4 port, 15 - 35dBmV individually adjustable RF outputs, 5 - 200MHz return bandwidth, wide optical input range down to -9dBm, and a unique backlit front panel control display - all in a temperature-controlled, 1 RU rack-mount chassis.

Technical Specifications

	Specifications	Values	Notes
General	Operating temp. (°C)	0 - 50	32 - 122°F
	Storage temp. (°C)	-40 - 85	
	Operating relative humidity (%)	5 - 95	Non-condensing
	Power Supply - 9 Volt AC	110 - 240	
	Power Consumption (W)	24	4 receivers
	Size (inches - WxDxH)	19 x 12 x 1.75	
	Interface port	RJ45, RS232	
Optical	Wavelength (nm)	1200 - 1620	
	Responsivity (A/W)	0.85	At 1310nm
	Input power level (dBm)	-9 - +1	
	Return loss (dB)	50	
	Output fiber connector	SC/APC	
RF	RF Bandwidth (MHz)	5 - 200	
	RF output level (dBmV)	15 - 35	+25 typical
	RF gain adjustment range (dB)	-15 - 0	1 dB steps
	Flatness (dB)	-0.75 - +0.75	
	Return loss (dB)	16	75Ω impedance
	RF connector (Main input)	F type	
	NPR (dB)	24	@-9dBm, 30dB

MUL-HRPR-4B

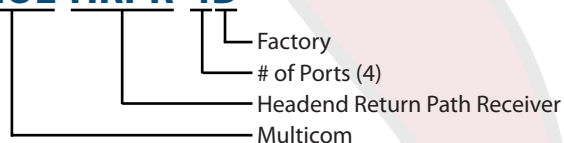

www.multicominc.com

Multicom, Inc.
 Ph: 800-423-2594 / 407-331-7779
 Fax: 407-339-0204
 Email: multicom@multicominc.com



Optical Transport Chassis

Description

The MUL-OTC-CH-V is an Optical Transport Chassis with universal CATV applications, high density, and powerful functionality and flexibility. The galvanized steel 4RU module shelf, CMM Display and Control Module, and Plug-in Power Modules are the basis of this product. The standard 19 inch shelf has 16 universal slots and fan cooling. The plug-in CMM Status Display and Control Module has a LCD status display and front panel pushbutton operation. Installing the Plug-in Application Modules into the shelf and putting the shelf into the cabinet creates an entire HFC headend in very little space.

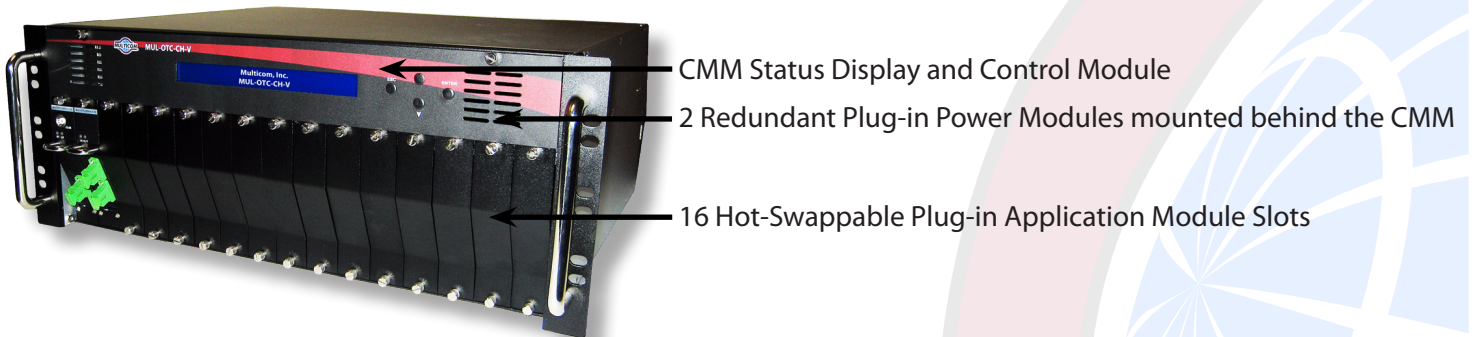

Plug-in Power Modules

The Plug-in Power Modules convert the AC power (DC optional), input power to supply the Application Modules in the OTC shelf. These modules use the newest switching power supply techniques, coupled with a high performance cooling design, to ensure high reliability. Each OTC system includes two redundant Plug-in Power Modules.

Plug-in Application Modules

Depending on optical fiber network design requirements, users can select the following optional Application Modules:

- » MUL-OTC-1310TX-V-X - 1310nm Forward Path Optical Transmitter Module
- » MUL-OTC-1550TX-V-X - 1550nm Forward Path Optical Transmitter Module
- » MUL-OTC-RPR-V - Forward Path Optical Receiver Module
- » MUL-OTC-RPR4-V - Four-channel Return Path Optical Receiver Module
- » MUL-OTC-EDFA-V-X - EDFA Optical Amplifier Module
- » MUL-OTC-OS-V - Optical Switch Module
- » MUL-OTC-PRFA-V - Pre RF Amplifier Module
- » MUL-OTC-RFS-V - RF Switch Module

Technical Specifications

Item	Unit	Technical Parameters
Shelf dimension	mm	483W x 176H x 420D - 4RU, 19" shelf
Ambient temperature range	°C	-25 ~ +55 (-13 ~ +131°F)
Humidity range	%	0 ~ 95 Non-condensing environment

MUL-OTC-CH-V

www.multicominc.com

Multicom, Inc.
Ph: 800-423-2594
Fax: 407-339-0204
Email: multicom@multicominc.com



1310nm Optical Transmitter Module

Key Features

- » High linearity, optically isolated, distributed AM feedback ORTEL DFB laser with optical output power options of 3, 6, 7.8, 10, 12 and 14.2dBm
- » Transmits NTSC, PAL, ATSC, and related digital information for CATV and/or telephony applications
- » 47-1003 MHz RF input bandwidth
- » Microprocessor-controlled diagnostics with digital processing technology and advanced RF pre-distortion circuit
- » Front panel SC/APC optical connectors allowing for ease in connecting optical fiber and cleaning optical connectors
- » Front panel LEDs display laser operation and RF input status



MUL-OTC-1310-V-X



MUL-OTC-CH-V

Description

The Multicom MUL-OTC-1310TX-V intelligent directly modulated optical transmitter module is designed to be used in the Multicom Optical Transport Chassis MUL-OTC-CH-V, and is mainly used in 1310nm optical fiber transmission systems. This 1310nm Module uses an ORTEL DFB laser with an optical output power options of 3, 6, 7.8, 10, 12 and 14.2dBm, and advanced intelligent electronic predistortion compensation technology.

This intelligent directly modulated optical transmitter is one of the most important components to build a CATV-HFC network. It is mainly used to transmit analog video, digital television signal, telephone voice signal and data (or compressed data) signal. This Multicom product provides a high quality low cost transmitter solution for a 1310nm optical fiber CATV system.

The Multicom 1310nm Optical Transmitter Module is a member of the Multicom OTC (Optical Transport Chassis) product family that includes the CMM Display and Control Module and dual redundant Power Modules in a 16 slot chassis. The OTC also supports the hot-swappable 1550nm Optical Transmitter Modules and EDFA modules, as well as alternative modules to meet your network needs.

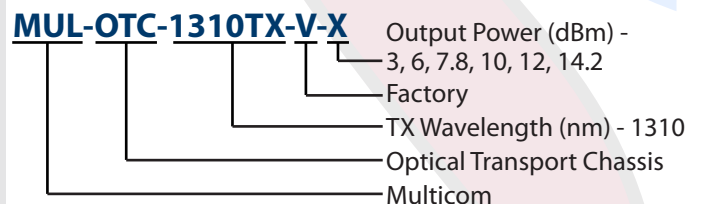

www.multicominc.com

Multicom, Inc.
Ph: 800-423-2594
Fax: 407-339-0204
Email: multicom@multicominc.com



1310nm Optical Transmitter Module

Product Specifications

Description

The Multicom MUL-OTC-1310TX-V intelligent directly modulated optical transmitter module is designed to be used in the Multicom Optical Transport Chassis MUL-OTC-CV-V, and is mainly used in 1310nm optical fiber transmission systems. This 1550nm Module uses an ORTEL DFB laser with an optical output power options of 2, 4, 6, 10, 16, 26dBm, and advanced intelligent electronic predistortion compensation technology.

This intelligent directly modulated optical transmitter is one of the most important components to build a CATV-HFC network. It is mainly used to transmit analog video, digital television signal, telephone voice signal and data (or compressed data) signal. This Multicom product provides a high quality low cost transmitter solution for a 1310nm optical fiber CATV system.

Technical Specifications

Item	Unit	Technical Parameters					
Optical output power	dBm	2	4	6	10	16	26
Optical link loss	dB	3	6	7.8	10	12	14.2
Optical wavelength	nm	1310 ± 20					
Laser type		ORTEL DFB laser					
Optical modulation mode		Direct optical intensity modulation					
Optical connector type		SC/APC					
Frequency range	MHz	47 ~ 1003 (depending on selected channel load)					
RF input level	dBmV	+15 to +25 (75 - 85 dBμV)					
Flatness in band	dB	± 0.75					
RF input impedance	Ω	75					
Input return loss	dB	≥ 16					
C/CSO	dB	≥ 65					
C/CTB	dB	≥ 60					
C/N	dB	≥ 51					
AGC control range	dB	± 5					
AGC adjustable range	dB	± 5					
MGC attenuation range	dB	0 - 15					
Consumption	W	25					
Operating temperature	°C	0 - +45 (+32 - +113°F)					
Storage temperature	°C	-20 - +65 (-4 - +150°F)					
Relative humidity	%	Max 95% no condensation					

MUL-OTC-1310TX-V-X

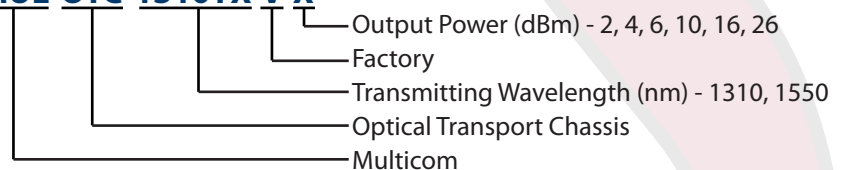

www.multicominc.com

Multicom, Inc.

Ph: 800-423-2594 / 407-331-7779

Fax: 407-339-0204

Email: multicom@multicominc.com



1550nm Optical Transmitter Module

Key Features

- » High linearity, optically isolated, distributed AM feedback ORTEL DFB laser with optical output power options of 3, 6, 7.8, 10, 12 and 14.2dBm
- » Transmits NTSC, PAL, ATSC, and related digital information for CATV and/or telephony applications
- » 47-1003 MHz RF input bandwidth
- » Microprocessor-controlled diagnostics with digital processing technology and advanced RF pre-distortion circuit
- » Front panel SC/APC optical connectors allowing for ease in connecting optical fiber and cleaning optical connectors
- » Front panel LEDs display laser operation and RF input status



MUL-OTC-1550TX-V-X



MUL-OTC-CH-V

Description

The Multicom MUL-OTC-1550TX-V intelligent directly modulated optical transmitter module is designed to be used in the Multicom Optical Transport Chassis MUL-OTC-CH-V, and is mainly used in 1550nm optical fiber transmission systems. This 1550nm Module uses an ORTEL DFB laser with optical output power options of 3, 6, 7.8, 10, 12 and 14.2dBm, and advanced intelligent electronic predistortion compensation technology.

This intelligent directly modulated optical transmitter is one of the most important components to build a CATV-HFC network. It is mainly used to transmit analog video, digital television signal, telephone voice signal and data (or compressed data) signal. This Multicom product provides a high quality low cost transmitter solution for a 1550nm optical fiber CATV system.

The Multicom 1550nm Optical Transmitter Module is a member of the Multicom OTC (Optical Transport Chassis) product family that includes the CMM Display and Control Module and dual redundant Power Modules in a 16 slot chassis. The OTC also supports the hot-swappable 1310nm Optical Transmitter Modules and EDFA modules, as well as alternative modules to meet your network needs.

MUL-OTC-1550TX-V-X

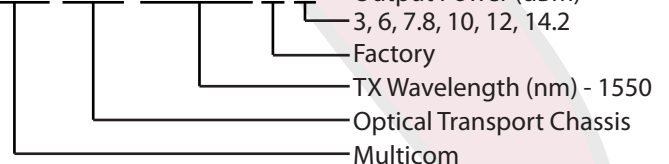

www.multicominc.com

Multicom, Inc.
Ph: 800-423-2594
Fax: 407-339-0204
Email: multicom@multicominc.com



1550nm Optical Transmitter Module

Product Specifications

Description

The MUL-OTC-1550TX-V intelligent directly modulated optical transmitter is mainly used in 1550nm optical fiber transmission systems. This 1550nm Module uses an ORTEL DFB laser with optical output power options of 3, 6, 7.8, 10, 12 and 14.2dBm, and advanced intelligent electronic predistortion compensation technology.

This intelligent directly modulated optical transmitter is one of the most important components to build a CATV-HFC network. It is mainly used to transmit analog video, digital television signal, telephone voice signal and data (or compressed data) signal. This Multicom product provides a high quality low cost transmitter solution for a 1550nm optical fiber CATV system.

Technical Specifications

Item	Unit	Technical Parameters					
Optical output power	mw	2	4	6	10	16	26
Optical output power	dBm	3	6	7.8	10	12	14.2
Optical wavelength	nm	1550 ± 20					
Laser type		ORTEL DFB laser					
Optical modulation mode		Direct optical intensity modulation					
Optical connector type		SC/APC					
Frequency range	MHz	47 ~ 1003 (depending on selected channel load)					
RF input level	dBmV	+15 to +25 (75 - 85 dBμV)					
Flatness in band	dB	± 0.75					
RF input impedance	Ω	75					
Input return loss	dB	≥ 16 (47 - 550MHz); ≥ 14 (550 - 1003MHz)					
C/CSO	dB	≥ 60					
C/CTB	dB	≥ 65					
C/N	dB	≥ 51					
AGC control range	dB	± 5					
AGC adjustable range	dB	± 5					
MGC attenuation range	dB	0 - 15					
Power consumption	W	25					
Operating temperature	°C	0 - +45 (+32 - +113°F)					
Storage temperature	°C	-20 - +65 (-4 - +150°F)					
Relative humidity	%	Max 95% no condensation					

MUL-OTC-1550TX-V-X

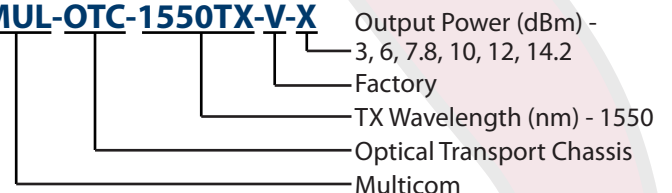

www.multicominc.com

Multicom, Inc.
Ph: 800-423-2594 / 407-331-7779

Fax: 407-339-0204

Email: multicom@multicominc.com



Four-Channel Return Path Optical Receiver Module

Key Features

- » Wide spectral bandwidth supporting 1100nm through 1600nm optical receiving wavelength range
- » High density chassis design with 4 HFC RPRs per module for up to 64 RPRs in a 4RU shelf
- » Remote management using SNMP allows easy integration to standard management systems
- » Status indicators, RF monitor and hot-swappable design for easy diagnostics & maintenance



MUL-OTC-RPR4-V



MUL-OTC-CH-V

Description

The Multicom MUL-OTC-RPR4-V Four-channel Return Path Optical Receiver Module is used for receiving return path television video and audio, digital television, and voice and data (or compressed data) signals. It uses E-O optical receiving devices and the signal amplifier incorporates a low noise GaAs module to ensure a high quality signal output.

Each Return Path Optical Receiver Module includes four optical receivers to receive four optical inputs and convert them into CATV RF, and then pre-amplify them independently. The RPR Module communicates with the CMM Display and Control Module (CMM) by A/D sampling, a switching circuit, and a status communication interface circuit.

The Multicom Four Channel Return Path Receiver Module is a member of the Multicom OTC (Optical Transport Chassis) product family that includes the CMM Display and Control Module and dual redundant Power Modules in a 16 slot chassis. The OTC also supports the hot-swappable 1310nm and 1550nm Transmitters Modules and EDFA modules, as well as alternative modules to meet your network needs.

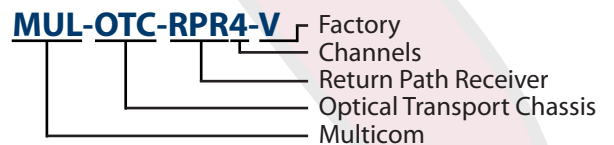

www.multicominc.com

Multicom, Inc.
Ph: 800-423-2594
Fax: 407-339-0204

Email: multicom@multicominc.com



Four-Channel Return Path Optical Receiver Module

Product Specifications

Description

The Multicom MUL-OTC-RPR4-V Four-channel Return Path Optical Receiver Module is used for receiving return path television video and audio, digital television, and voice and data (or compressed data) signals. It uses E-O optical receiving devices and the signal amplifier incorporates a low noise GaAs module to ensure a high quality signal output.

Each Return Path Optical Receiver Module includes four optical receivers to receive four optical inputs and convert them into CATV RF, and then pre-amplify them independently. The RPR Module communicates with the CMM Display and Control Module (CMM) by A/D sampling, a switching circuit, and a status communication interface circuit.

Technical Specifications

Item	Unit	Technical Parameters
Optical Parameters		
Receiving optical power range	dBm	-10 ~ +1
Optical AGC range	dBm	-9 ~ +1
Optical return loss	dB	≥45
Optical receiving wavelength range	nm	1100 ~ 1600
Optical connector type		SC/APC
Fiber type		Singlemode
RF Parameters		
Frequency range	MHz	5 ~ 200
Output level	dBmV	38
Flatness in band	dB	≤0.75
Return loss	dB	16
Output impedance		75
Level adjustable range	dB	0 ~ 10
RF test port	dB	-20
Stability of RF output level	dB	<1
NPR dynamic range	dB	15
Link performance		
C/N	dB	51
C/CTB	dB	65
C/CSO	dB	60
General Characteristics		
Consumption	W	<25
Operating Temperature	°C	0 ~ 45 (32 - 113 °F)
Storage Temperature	°C	-20 ~ 65 (-4 - 149 °F)

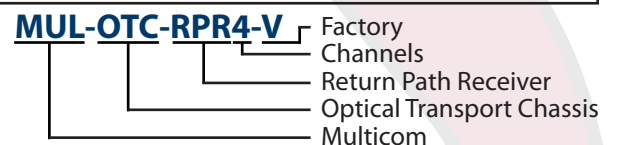

www.multicominc.com

Multicom, Inc.

Ph: 800-423-2594 / 407-331-7779

Fax: 407-339-0204

Email: multicom@multicominc.com



EDFA Optical Amplifier Module

Key Features

- » High-performance Erbium Doped Fiber Amplifier with a JDSU Pump Laser for high efficiency energy conversion
- » Automatic monitoring circuitry accurately monitors and controls the optical output power, temperature and various parameters of the pump laser ensuring stable optical output power effectively extend the working life of the pump laser.
- » Input and output optical power detection to adjust the laser pump automatically and keep the output optical power of the EDFA module constant



MUL-OTC-EDFA-V-X



MUL-OTC-CH-V

Description

The Multicom MUL-OTC-EDFA-V-X 1550nm Erbium Doped Fiber Amplifier (EDFA) Module is a low noise 1550nm optical amplifier designed to be used in the Multicom Optical Transport Chassis MUL-OTC-CH-V. Available optical output levels range from 13 to 24dBm.

This hot pluggable EDFA is designed to amplify 1550nm optical signals to increase the optical transmission distance over fiber, and can be used in conjunction with the Multicom 1550nm Optical Transmitter Module.

The EDFA Module includes input and output optical power detection to adjust the laser pump automatically and keep the output optical power of the EDFA module constant. Internal control circuitry accurately maintains the output power and temperature of the laser. This module communicates with the CMM status control and display unit by A/D sampling, a switching circuit, and a communication interface circuit.

The Multicom EDFA Optical Amplifier Module is a member of the Multicom OTC (Optical Transport Chassis) product family that includes the CMM Display and Control Module and dual redundant Power Modules in a 16 slot chassis. The OTC also supports the hot-swappable 1310nm and 1550nm Transmitters Modules and Four-Channel Return Path Receiver Module, as well as alternative modules to meet your network needs.

MUL-OTC-EDFA-V-X

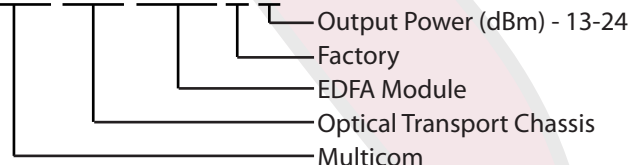

www.multicominc.com

Multicom, Inc.
 Ph: 800-423-2594 / 407-331-7779

Fax: 407-339-0204

Email: multicom@multicominc.com



EDFA Optical Amplifier Module

Product Specifications

Description

The Multicom MUL-OTC-EDFA-V 1550nm high-performance Erbium Doped Fiber Amplifier (EDFA) Module with a JDSU Pump Laser is a low noise 1550nm optical amplifier designed to be used in the Multicom Optical Transport Chassis MUL-OTC-CH-V. Available optical output levels range from 13 to 24dBm.

This hot pluggable EDFA is designed to amplify 1550nm optical signals to increase the optical transmission distance over fiber, and can be used in conjunction with the Multicom 1550nm Optical Transmitter Module.

The EDFA Module includes input and output optical power detection to adjust the laser pump automatically and keep the output optical power of the EDFA module constant. Internal control circuitry accurately maintains the output power and temperature of the laser. This module communicates with the CMM status control and display unit by A/D sampling, a switching circuit, and a communication interface circuit.

Technical Specifications

Item	Unit	Technical Parameter	Notes
Operating bandwidth	nm	1535 - 1565	
Optical input power range	dBm	-5 - +10	Suggested input 0 - +5dBm
Optical output power	dBm	18	13-24dBm available
Output power stability	dBm	± 0.5	
Noise figure	dB	≤ 5.0	Optical input power 0dBm
Return loss - Input port	dB	≥ 45	
Return loss - Output port	dB	≥ 45	
Pump leakage power - Input port	dBm	≤ -30	
Pump leakage power - Output port	dBm	≤ -30	
C/N	dB	≥ 52	
C/CTB	dB	≥ 63	
C/CSO	dB	≥ 63	
Optical connector type		SC/APC	
Operating temperature range	°C	-5 - +55	23 - 130°F
Storage temperature range	°C	-30 - +70	-22 - 158°F
Max operating/storage relative humidity	%	95	No condensation

MUL-OTC-EDFA-V-X

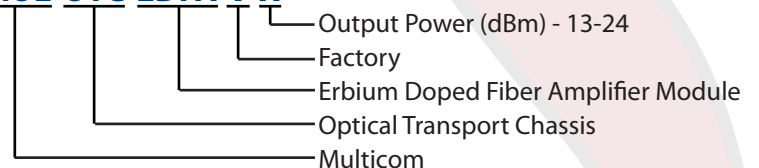

www.multicominc.com

Multicom, Inc.

Ph: 800-423-2594 / 407-331-7779

Fax: 407-339-0204

Email: multicom@multicominc.com



Channel Elimination Filter / Modulator Combination Unit

Key Features

- Channel Elimination and Modulator incorporated in one package
- No need for expensive processors
- Able to eliminate and reinsert either digital or analog signals
- Easy installation
- No external coupling required
- 1 RU rack mount or wall mount

Applications

- Schools: Broadcast local content instead of a cable channel
- MDUs: Add security cameras to your programming
- Hotel/Motel: Add premium digital channels to analog distribution without adding set top boxes to every room or changing out televisions
- Hospitals/Hotels/Motels: Add a directory/advertising channel to your programming
- Homeowners Associations: Add a community directory/content channel to your programming



Rack mount



Wall mount

Description

Make Reinsertion Projects Easy and Economical:

The Multicom Channel Elimination Filter / Modulator Combination Unit incorporates a channel elimination filter with a single channel modulator. This allows the removal of a selected channel or frequency to make way for the reinsertion of a premium digital channel or locally originating signal.

RCA Inputs for Reinsertion of:

- Set-top box
- VCR
- DVD
- Security camera
- Character generator
- Media player

Additional Options

- Agile Video Modulator (Part# M-CEFMOD-AG-NN-X)
- Agile Stereo Video Modulator (Part# M-CEFMOD-AS-NN-X)

M-CEFMOD-NN-X

Channel Number R=Rack
W=Wall

www.multicominc.com

Multicom, Inc.

Ph: 800-423-2594

Fax: 407-339-0204

Email: multicom@multicominc.com



Channel Elimination Filter / Modulator Combination Unit

Product Specifications

Key Features

- Removes a selected channel or frequency to make way for the reinsertion of a premium digital channel or locally originating signal
- Channel Elimination and Modulator incorporated in one package
- No need for expensive processors
- Able to eliminate and reinsert either digital or analog signals
- Easy installation
- No external coupling required
- 1 RU rack mount or wall mount

Specifications

Channel Elimination Filter	Specifications
Channels	2 through 125
Passband	5 MHz-1GHz (ch 2-125)
Channel rejection	-55 dB typical
Adjacent carrier loss	-3.0 dB typical
Insertion loss	-1 dB typical
Temperature range	32° to 140°F
Impedence	75 Ohms

RCA Inputs for Reinsertion of:

- Set-top box
- VCR
- DVD
- Security camera
- Character generator
- Media player

Additional Options

- Agile Video Modulator
(Part# M-CEFMOD-AG-NN-X)
- Agile Stereo Video Modulator
(Part# M-CEFMOD-AS-NN-X)

Modulators	Specifications
Frequency selection	CATV channels 2-125 (standard, HRC, or IRC), with automatic FCC frequency offsets
Output level	+33 dbmv adjustable to +23 dbmv with internal 12 dB directional coupler
Power requirements	120 VAC, 60 Hz, 0.16 Amps - UL & CSA listed
Inputs - Video	1 volt peak to peak, RCA female
Inputs - Audio	500 mV peak to peak, RCA female

M-CEFMOD-NN-X

Channel Number R=Rack
W=Wall

www.multicominc.com

Multicom, Inc.
Ph: 800-423-2594 / 407-331-7779
Fax: 407-339-0204
Email: multicom@multicominc.com



Multicom IRH Panel

Description

The Multicom M-IRH-PANEL is a professional quality, headend rack product designed for wall mount components on a standard 19" rack.

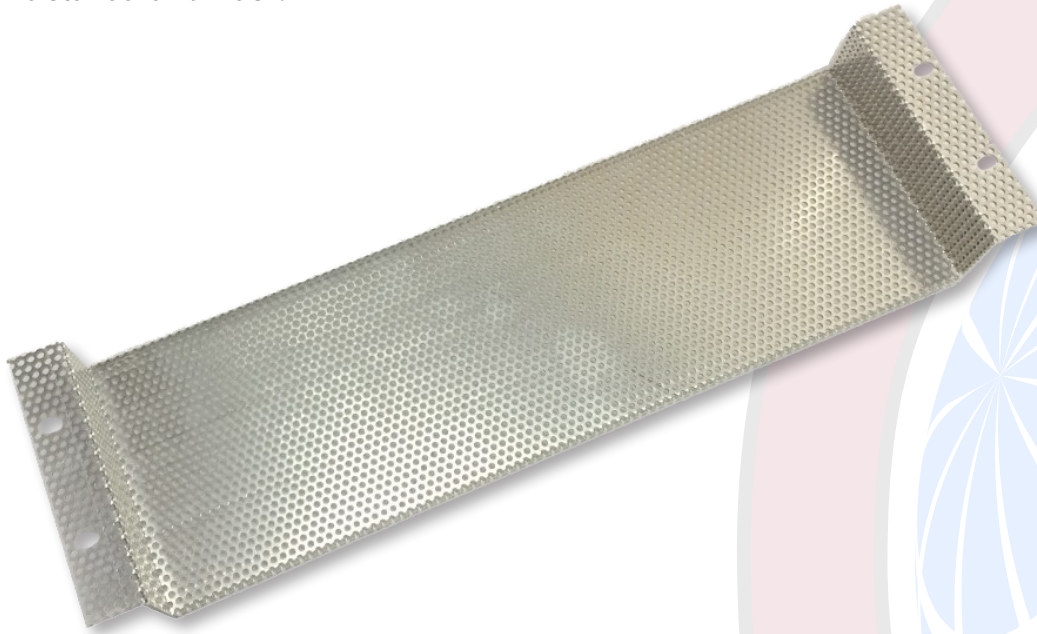

General Features

The dimensions are 19"W x 5.25"H x 1.75"D

Part# M-IRH-PANEL

www.multicominc.com

Multicom, Inc.
Ph: 800-423-2594
Fax: 407-339-0204

Email: multicom@multicominc.com



Satellite Multiswitch Chassis and Kit

Key Features

- Highly recommended for new installations to provide the quality and performance of DISH Network's Pro Series dishes and receivers
- Ideally suited for MDU, hotel/motel, and all other multi-dish headend applications
- Rackmount - 2RU high
- Compact, Simple to use
- Can be purchased as a kit or fully assembled



Rear of assembled unit with lid removed → Three Satellite Inputs

Description

For the first time available anywhere, Multicom is providing this unique rack-mountable 3 in x 12 out Satellite Multiswitch system providing input connectivity for up to three DISH Network Satellite 500 and/or 300 dishes and outputs for up to 12 receivers all within a single compact rackmount unit.

The MUL-MS34-CH/A incorporates three DISH Network Model DP34 Multi-Dish Switches with the highest quality headend connectorization and cabling.

Part#s and Configurations

MUL-MS34-CH/K - Rack Mount Kit for three DISH Network Model DP34 Multi-Dish Switches including the Chassis and all of the necessary Jumper Cables and Connectors to assemble the complete unit. Does not include the DP34s.

MUL-MS34-CH/A - Completely assembled rackmount unit **including** three DISH Network Model DP34 Multi-Dish Switches (as shown above).

MUL-MS34-CH/K

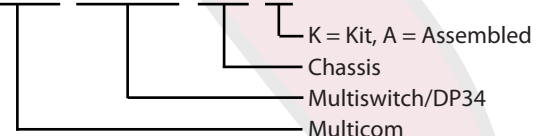

www.multicominc.com

Multicom, Inc.
Ph: 800-423-2594 / 407-331-7779

Fax: 407-339-0204

Email: multicom@multicominc.com



High Power Optical Micro-Node

Key Features

- » Uses an advanced optical AGC circuit design, with an optical AGC control range of: +2dBm ~ -9/-8/-7/-6/-5/-4dBm adjustable
- » Features the high quality, high reliability DFB laser
- » Forward operating frequency up to 1GHz, RF amplifier uses a high performance low power consumption GaAs amplifier, maximum output level up to 52dBmV
- » EQ and ATT both use an advanced electric control circuit for setting the operating parameters, making the setup easier and more accurate

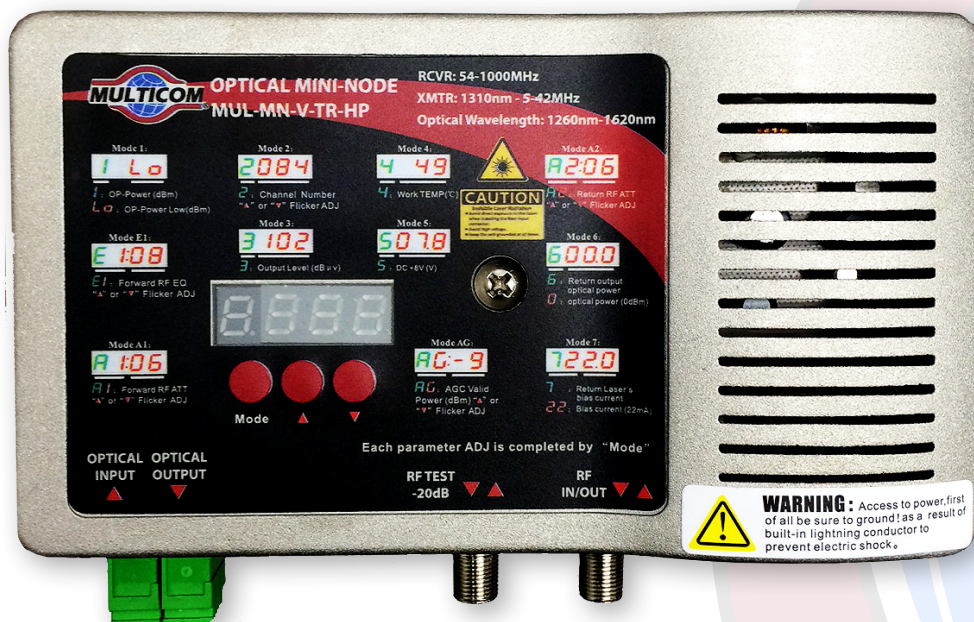

Description

The MUL-MN-V-TR-HP optical receiver is a bi-directional receiver specifically developed for HFC broadband networks. It accommodates the FTTH (Fiber to the Home) network topology, while addressing the issues of CATV bidirectional return channel noise and the high reliability network security transmission requirements of modern CATV networks.

MUL-MN-V-TR-HP

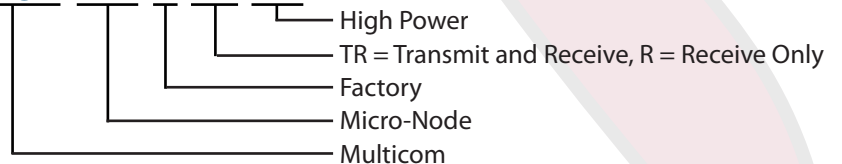

www.multicominc.com

Multicom, Inc.
 Ph: 800-423-2594
 Fax: 407-339-0204
 Email: multicom@multicominc.com



High Power Optical Micro-Node

Product Specifications

Item	Unit	Technical Parameter
Forward Optical Receiver		
Optical Parameters		
Optical Receiving Power	dBm	-9 ~ +2
Optical AGC Range	dBm	+2 ~ -9/-8/-7/-6/-5/-4 (adjustable)
Optical Return Loss	dB	> 45
Optical Receiving Wavelength	nm	1260 ~ 1620
Optical Connector Type		SC/APC
Fiber Type		Single Mode
Link Performance		
C/N	dB	≥ 51
C/CTB	dB	≥ 60
C/CSO	dB	≥ 60
RF Parameters		
Frequency Range	MHz	54 ~ 1000
Flatness in Band	dB	± 0.75
Test Port	dB	-20
Rated Output Level	dBmV	≥ 108 dBμV (≥ +48 dBmV)
Max Output Level	dBmV	+49 (≥ 109 dBμV) (when input optical power -9 ~ +2dBm)
		+52 (≥ 112 dBμV) (when input optical power -7 ~ +2dBm)
Output Return Loss	dB	≥ 16
Output Impedance	Ω	75
Electrical Control EQ Range	dB	0 ~ 15
Electrical Control ATT Range	dB	0 ~ 15
Return Optical Transmitter		
Optical Parameters		
Optical Transmit Wavelength	nm	1310 ±10
Laser Type		DFB
Optical Output Power	mW	1 ± 0.5
Optical Connector Type		SC/APC
RF Parameters		
Frequency Range	MHz	5 ~ 42
Flatness in Band	dB	±1
Input Level	dBmV	+15 ~ +25 (75 ~ 85 dBμV)
Output Impedance	Ω	75
NPR Dynamic Range	dB	≥15 (NPR ≥30 dB) Using DFB Laser
General Statistics		
Power Voltage	V	12VDC (from the included AC Adapter)
Operating Temperature	°C	-30 ~ +60 (-22 ~ +140°F)
Storage Temperature	°C	-40 ~ +65 (-40 ~ +150°F)
Relative Humidity	%	Max 95% no condensation
Consumption	W	≤ 9
Dimensions	mm	190 (L) x 110 (W) x 52 (H) (7.5in x 4.3in x 2in)

MUL-MN-V-TR-HP

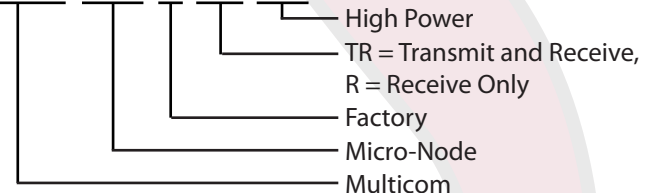

www.multicominc.com

Multicom, Inc.
 Ph: 800-423-2594 / 407-331-7779
 Fax: 407-339-0204
 Email: multicom@multicominc.com



Optical Micro-Node

Key Features

- » The laser control circuit uses advanced circuit design, insuring reliable and stable operation
- » Provides excellent AGC characteristics, when the input optical power range is within $-7 \sim +2\text{dBm}$, the RF output level remains unchanged, CTB and CSO basically remain unchanged
- » Optimized circuit design, SMT production process, optimizing the entire signal path, makes the optical signal transmission more stable, RF linear indicators higher
- » Professional RF attenuator circuit, with good linear attenuation and high precision
- » GaAs amplifier device, with good index, low distortion, and high reliability
- » Aluminum die casting for efficient cooling, and reliable, stable performance



Description

The MUL-MN-V-TR optical receiver is bidirectional equipment that was specially developed for HFC broadband networks, accommodates FTTH (Fiber to the Home) network topology, while addressing the issues of CATV bidirectional return channel noise and high reliability network security transmission requirements of modern CATV networks.

MUL-MN-V-TR

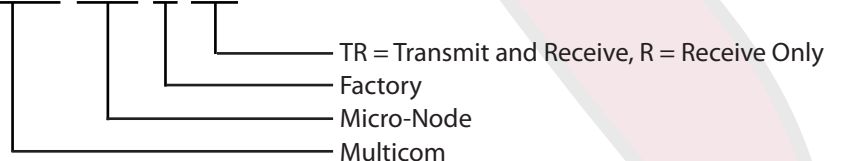

www.multicominc.com

Multicom, Inc.
Ph: 800-423-2594
Fax: 407-339-0204
Email: multicom@multicominc.com



Optical Micro-Node

Product Specifications

Item	Unit	Technical Parameter
Forward Optical Receiver		
Optical Parameters		
Optical Receiving Power	dBm	-7 ~ +2
Suggested Use Range	dBm	-3 ~ +1
Optical Return Loss	dB	> 45
Optical Receiving Wavelength	nm	1260 ~ 1620
Optical Connector Type		SC/APC
Fiber Type		Single Mode
Link Performance		
C/N	dB	≥ 51 received optical power (-1dBm)
C/CTB	dB	≥ 63
C/CSO	dB	≥ 60
RF Parameters		
Frequency Range	MHz	54 ~ 1000
Flatness in Band	dB	± 0.75
Rated Output Level	dBmV	≥ +32 (≥ 92 dBμV)
Max Output Level	dBmV	≥ +32 (≥ 92 dBμV)
Output Return Loss	dB	≥ 16
Output Impedance	Ω	75
Return Optical Transmitter		
Optical Parameters		
Optical Transmit Wavelength	nm	1310 ±10
Laser Type		FP laser
Optical Output Power	mW	1 ± 0.5
Optical Connector Type		SC/APC
RF Parameters		
Frequency Range	MHz	5 ~ 42
Flatness in Band	dB	±0.75
Input Level	dBmV	+15 ~ +25 (75 ~ 85 dBμV)
Input Return Loss	dB	≥ 16
Output Impedance	Ω	75
NPR Dynamic Range	dB	≥10 (NPR ≥30 dB) Using the FP laser
General Statistics		
Power Voltage	V	+12VDC (from the included AC Adapter)
Operating Temperature	°C	-30 ~ +70 (-22 ~ +158°F)
Storage Temperature	°C	-30 ~ +70 (-22 ~ +158°F)
Relative Humidity	%	Max 95% no condensation
Consumption	W	≤ 6
Dimensions	mm	154 (L) x 116(W) x 26(H) (6in x 4.6in x 1in)

MUL-MN-V-TR

www.multicominc.com

Multicom, Inc.
 Ph: 800-423-2594 / 407-331-7779
 Fax: 407-339-0204
 Email: multicom@multicominc.com



Optical Micro-Node Receiver

Product Specifications

The **MUL-MN-V-R** Optical Micro-Node Receiver is equipment that was specially developed for HFC broadband networks, accommodating FTTH (Fiber to the Home) network topology.

- Mini size, easy to install
- Operating frequency up to 1GHz
- RF amplifier uses a high performance low power consumption GaAs amplifier
- 12VDC power supply



Item	Unit	Technical Parameter
Optical Parameters		
Optical Receiving Power	dBm	-15 ~ +2
AGC Range	dBm	-7 ~ +2
Optical Return Loss	dB	> 45
Optical Receiving Wavelength	nm	1100 ~ 1600
Optical Connector Type		SC/APC
Fiber Type		Single Mode
Link Performance		
C/N	dB	≥ 51
C/CTB	dB	≥ 65
C/CSO	dB	≥ 62
-1dBm Optical Power Received		
RF Parameters		
Frequency Range	MHz	45 ~ 1003
Flatness in Band	dB	± 0.75
Rated Output Level	dBmV	≥ +28 (≤88 dBμV)
Output Return Loss	dB	≥ 16
Output Impedance	Ω	75
General Statistics		
Consumption	W	< 3
Operating Temperature	°C	-20 ~ +55 (-4 ~ +150°F)
Dimensions	mm	105 (L) x 67(W) x 24(H) (4in x 2.6in x 1in)

MUL-MN-V-R

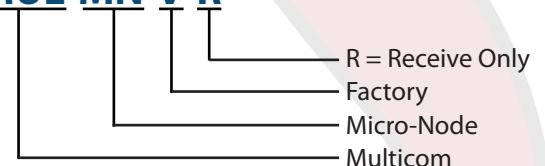

www.multicominc.com

Multicom, Inc.
 Ph: 800-423-2594 / 407-331-7779
 Fax: 407-339-0204
 Email: multicom@multicominc.com



RFOG Optical Micro-Node

Key Features

- » The laser control circuit uses advanced circuit design, ensuring reliable and stable operation
- » Provides excellent AGC characteristics - when the input optical power range is within $-7 \sim +2\text{dBm}$, the RF output level remains unchanged
- » Optimized circuit design using the SMT production process optimizes the entire signal path, making the optical signal transmission more stable
- » Professional RF attenuator circuit ensures excellent linear attenuation
- » GaAs amplifier device provides low distortion and high reliability
- » Aluminum die casting for efficient cooling and stable performance

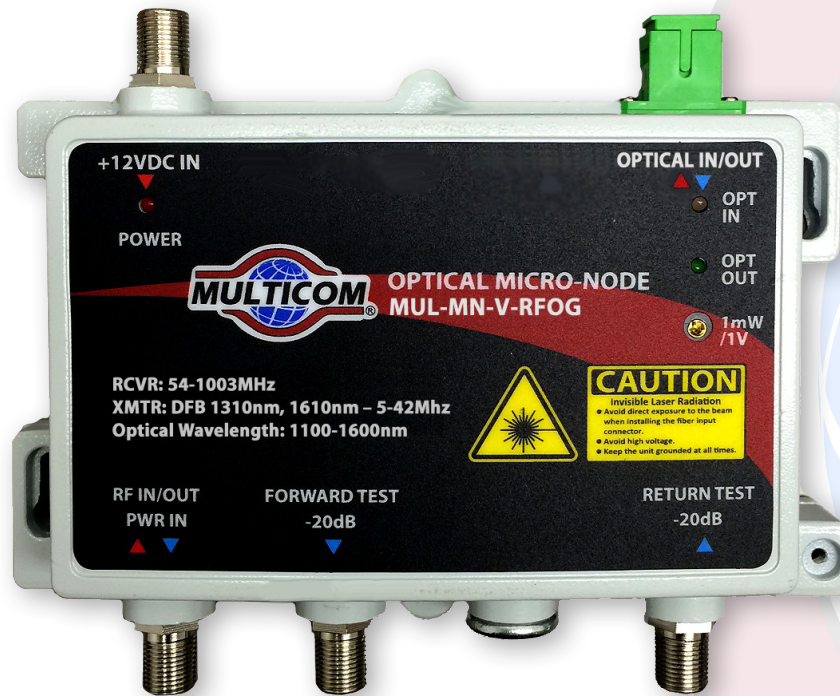

Description

The MUL-MN-V-RFOG optical receiver is bidirectional equipment that was specially developed for HFC broadband networks, accommodates FTTH (Fiber to the Home) network topology, while addressing the issues of CATV bidirectional return channel noise and high reliability network security transmission requirements of modern CATV networks.

MUL-MN-V-RFOG

www.multicominc.com

Multicom, Inc.
Ph: 800-423-2594
Fax: 407-339-0204
Email: multicom@multicominc.com



RFOG Optical Micro-Node

Product Specifications

Item	Unit	Technical Parameter
Forward Optical Receiver		
Optical Parameters		
Optical Receiving Power	dBm	-7 ~ +2
Suggested Use Range	dBm	-3 ~ +1
Optical Return Loss	dB	> 45
Optical Receiving Wavelength	nm	1100 ~ 1600
Optical Connector Type		SC/APC
Fiber Type		Single Mode
Link Performance		
C/N	dB	≥ 51 received optical power (-1dBm)
C/CTB	dB	≥ 63
C/CSO	dB	≥ 60
RF Parameters		
Frequency Range	MHz	54 ~ 1003
Flatness in Band	dB	± 0.75
Rated Output Level	dBmV	+32 (≥ 92 dBμV)
Max Output Level	dBmV	+32 (≥ 92 dBμV)
Output Return Loss	dB	≥ 16
Output Impedance	Ω	75
Return Optical Transmitter		
Optical Parameters		
Optical Transmit Wavelength	nm	1310 ±10, 1610 ±10
Laser Type		DFB laser
Optical Output Power	mW	0.5 ~ 2
Optical Connector Type		SC/APC
RF Parameters		
Frequency Range	MHz	5 ~ 42 (up to 55/65 optional)
Flatness in Band	dB	±0.75
Input Level	dBmV	+15 ~ +25 (75 ~ 85 dBμV - suggested input 80)
Input Return Loss	dB	≥ 16
Output Impedance	Ω	75
NPR Dynamic Range	dB	≥15 (NPR ≥30 dB) Using the DFB laser
General Statistics		
Power Voltage	V	+12VDC (from the included AC Adapter)
Operating Temperature	°C	-30 ~ +70 (-22 ~ +158°F)
Storage Temperature	°C	-30 ~ +70 (-22 ~ +158°F)
Relative Humidity	%	Max 95% no condensation
Consumption	W	≤ 6
Dimensions	mm	154 (L) x 116(W) x 26(H) (6in x 4.6in x 1in)

MUL-MN-V-RFOG

www.multicominc.com

Multicom, Inc.
 Ph: 800-423-2594 / 407-331-7779
 Fax: 407-339-0204
 Email: multicom@multicominc.com

SECTION D

SATELLITE DISHES & LNBS	PAGE
SATELLITE DISHES	
• 75 CM	73
• 90 CM	74
• 1.8 METER	75
• 2.4 METER	76
• 3.0 METER	77
LNB - KU BAND	
• SINGLE	78
• DUAL	79
• QUAD	80
• OCTO	81

BACK TO MAIN TABLE OF CONTENTS



75cm DTH Satellite Dish

Product Specifications

Description

The Multicom 75cm Direct to Home (DTH) KU band satellite dish provides strong, clear reception. This high quality dish is designed to withstand high winds, minimize rain fade and improve signal strength. Made with high strength galvanized steel, it's simple to assemble and install, making it a excellent choice for cost effective installations.

SPECIFICATIONS	
Model	Multicom 75cm Direct to Home (DTH)
Type	KU Band - Offset
Diameter short axis	75cm
Diameter long axis	82.5cm
Thickness	0.7mm
KU band gain	38.52 dBi (min) @ 12.5 GHz
F/D ratio	0.65
Efficiency	75% (min)
Frequency range	10.7 - 12.75 GHz
Focus distance	492mm
Material	Galvanized steel
Surface	Electrostatic polyester
LNB holder	40mm
Mount type	Universal wall/floor/roof mount
Angle of elevation	20 - 90°
Max. Operational Wind Speed	90 km/hr
Ambient temperature	-40°C to +60°C
Relative humidity	0% - 100 %
Wind tunnel tested design	Yes
Salt spray tested finish	Yes
UV durability tested finish	Yes

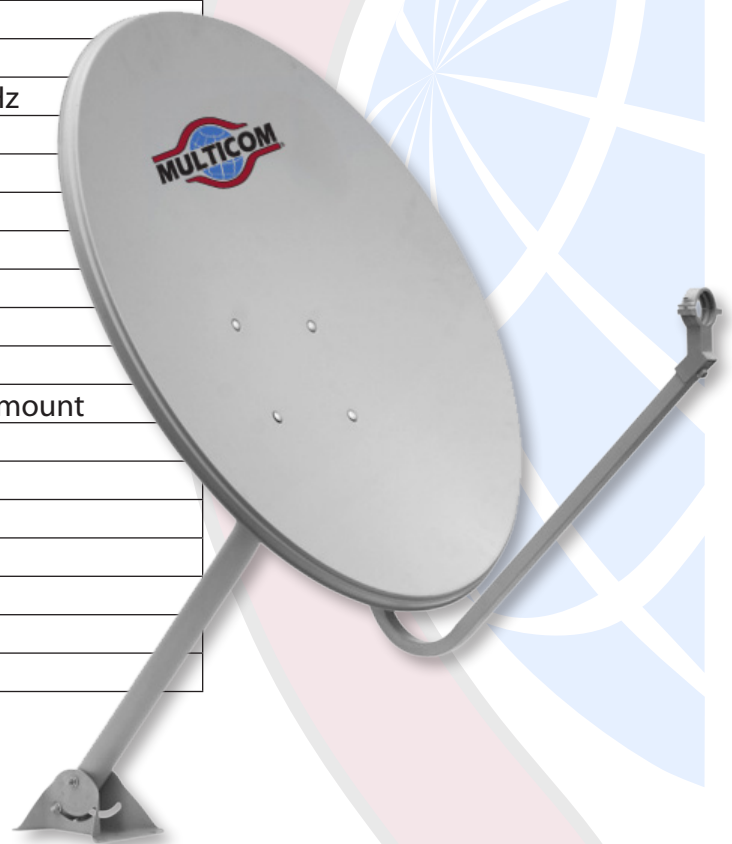

Options:

- Various mount configurations
- Custom logo



MUL-75CM-KU

www.multicominc.com

Multicom, Inc.
Ph: 407-331-7779
800-423-2594

Email: multicom@multicominc.com



90cm DTH Satellite Dish

Product Specifications

Description

The Multicom 90cm Direct to Home (DTH) Satellite Dish provides strong, clear reception. This high quality dish is designed to withstand high winds, minimize rain fade and improve signal strength. Made with high strength galvanized steel, it's simple to assemble and install, making it a excellent choice for cost effective installations.

SPECIFICATIONS	
Model	Multicom 90cm Direct to Home (DTH)
Type	KU Band - Offset
Diameter short axis	90cm
Diameter long axis	99cm
Thickness	0.7mm
KU band gain	40.32 dBi (min) @ 12.5 GHz
F/D ratio	0.60
Efficiency	80% (min)
Frequency range	10.7 - 12.75 GHz
Focus distance	540mm
Material	Galvanized steel
Surface	Electrostatic polyester
LNB holder	40mm
Mount type	Universal wall/floor/roof mount
Angle of elevation	0 - 90°
Max. Operational Wind Speed	90 km/hr
Ambient temperature	-40°C to +60°C
Relative humidity	0% - 100 %
Wind tunnel tested design	Yes
Salt spray tested finish	Yes
UV durability tested finish	Yes



Options:

- Various mount configurations
- Custom logo



MUL-90CM-KU

www.multicominc.com

Multicom, Inc.
Ph: 407-331-7779
800-423-2594

Email: multicom@multicominc.com



1.8 Meter Prime Focus Satellite Dish

Product Specifications

SPECIFICATIONS REFLECTOR	
Model	MUL-1.8M-S
Panels	6
Diameter	1.8 Meters (5.90 Ft)
Thickness	0.5mm
Frequency Range	3.7 - 4.2 GHz (C-Band)
C-Band Gain @ 4.0GHz	36dB
F/D Ratio	0.38
Focus Length	684mm
Material	Steel
Surface	Polyester Powder Coating
Angle of Elevation	0 - 90°
Level	Fixed 0 - 360°
Aperture Efficiency	75%
Operational Windspeed	25 m / sec
Survival Windspeed	40 m / sec
Maximum Windspeed	60 m / sec
Ambient Temperature	-40 ~ +60°C
Relative Humidity	0 ~ 100 %



MUL-1.8M-S

Does not include Feed Horn and LNB

www.multicominc.com

Multicom, Inc.
Ph: 407-331-7779 | 800-423-2594

Fax: 407-339-0204

Email: multicom@multicominc.com



2.4 Meter Prime Focus Satellite Dish

Product Specifications

SPECIFICATIONS REFLECTOR	
Model	MUL-2.4M-S
Panels	6
Diameter	2.4 Meters (7.87 Ft)
Thickness	0.8mm
Frequency Range	3.7 - 4.2 GHz (C-Band)
C-Band Gain @ 4.0GHz	38.39dB
F/D Ratio	0.38
Focus Length	912mm
Material	Steel
Surface	Polyester Powder Coating
Angle of Elevation	0 - 90°
Level	Fixed 0 - 360°
Aperture Efficiency	75%
Operational Windspeed	25 m / sec
Survival Windspeed	40 m / sec
Maximum Windspeed	60 m / sec
Ambient Temperature	-40 ~ +60°C
Relative Humidity	0 ~ 100 %



MUL-2.4M-S

Does not include Feed Horn and LNB

www.multicominc.com

Ph: 407-331-7779 | 800-423-2594

Fax: 407-339-0204

Email: multicom@multicominc.com



3.0 Meter Prime Focus Satellite Dish

Product Specifications

SPECIFICATIONS REFLECTOR	
Model	MUL-3.0M-S
Panels	12
Diameter	3 Meters (9.84 Ft)
Thickness	1.0mm
Net Weight	90 Kg (199 Lbs)
Frequency Range	3.7 - 4.2 GHz (C-Band)
C-Band Gain @ 4.0GHz	40.61dB
F/D Ratio	0.36
Focus Length	1078mm
Material	Steel
Surface	Polyester Powder Coating
Angle of Elevation	0 - 90°
Level	Fixed 0 - 360°
Aperture Efficiency	75%
Operational Windspeed	25 m / sec
Survival Windspeed	40 m / sec
Maximum Windspeed	60 m / sec
Ambient Temperature	-40 ~ +60°C
Relative Humidity	0 ~ 100 %



MUL-3.0M-S

Does not include Feed Horn and LNB

www.multicominc.com

Multicom, Inc.
Ph: 407-331-7779 | 800-423-2594

Fax: 407-339-0204

Email: multicom@multicominc.com



Single LNB

Product Specifications

Description

Specifically designed for the DTH markets, this LNB provides optimized reception capabilities. This Single Port LNB enables the reception of signal from one satellite and its distribution to a single-tuner set-top boxes and is ready for High-Definition transmissions and provides excellent noise figure performance. Manufactured to the highest industry quality standards and designed to meet strict specifications this LNB is an ideal solution for the satellite broadcast reception across Europe and South America.



Features:

- Low Phase Noise
- Low Noise Figure
- Low Power Consumption
- High Cross Polarization Isolation
- High Frequency Stability

Parameter	Specification
Ports	1
Low Band Input Frequency Range	10.7~11.7 GHz
Low Band Output Frequency Range	950~1950 MHz
Low Band LO Frequency	9.75 GHz
High Band Input Frequency	11.7~12.75 GHz
High Band Output Frequency Range	1100~2150 MHz
High Band LO Frequency	10.6 GHz
Noise Figure	0.5 dB typ.
LO Initial Accuracy	+/- 1.0 MHz max.
LO Temperature Drift	+/- 2.0 MHz max.
Phase Noise @ 10KHz)	-90 dBc/Hz max.
Conversion Gain	60 dB min.
Gain Ripple	+/- 0.50 dB/36 MHz
Gain Variation	+/- 4 dB
Image Rejection	50 dB min.
1 dB Compression Point @ Output	0.0 dBm min.
Cross Talk	23 dB min.
Control Signals Ca (V)	11.0~14.0 V
Control Signals Cb (H)	16.0~20.0 V
Control Signals Cc (Band Switching)	22 KHz +/- 4 KHz
Output VSWR	2.5 : 1
Radiated Interference	-50 dBm max.
DC Power	130mA max.
Working Temperature	-40°C ~ +60°C
Output Impedance (Connected to STB)	75Ω
Output Connector	F-type (female)



MUL-SINGLE-LNB

www.multicominc.com

Multicom, Inc.
Ph: 407-331-7779
800-423-2594

Email: multicom@multicominc.com



Twin LNB

Product Specifications

Description

Specifically designed for the DTH markets, this LNB provides optimized reception capabilities. This two Port LNB enables the reception of signal from one satellite and its distribution to two set-top boxes and is ready for High-Definition transmissions and provides excellent noise figure performance. Manufactured to the highest industry quality standards and designed to meet strict specifications this LNB is an ideal solution for the satellite broadcast reception across Europe and South America.



Features:

- Low Phase Noise
- Low Noise Figure
- Low Power Consumption
- High Cross Polarization Isolation
- High Frequency Stability

Parameter	Specification
Ports	2
Low Band Input Frequency Range	10.7~11.7 GHz
Low Band Output Frequency Range	950~1950 MHz
Low Band LO Frequency	9.75 GHz
High Band Input Frequency	11.7~12.75 GHz
High Band Output Frequency Range	1100~2150 MHz
High Band LO Frequency	10.6 GHz
Noise Figure	0.5 dB typ.
LO Initial Accuracy	+/- 1.0 MHz max.
LO Temperature Drift	+/- 2.0 MHz max.
Phase Noise @ 10KHz)	-90 dBc/Hz max.
Conversion Gain	60 dB min.
Gain Ripple	+/- 0.50 dB/36 MHz
Gain Variation	+/- 4 dB
Image Rejection	50 dB min.
1 dB Compression Point @ Output	0.0 dBm min.
Cross Talk	23 dB min.
Control Signals Ca (V)	11.0~14.0 V
Control Signals Cb (H)	16.0~20.0 V
Control Signals Cc (Band Switching)	22 KHz +/- 4 KHz
Output VSWR	2.5 : 1
Radiated Interference	-50 dBm max.
DC Power	130mA max.
Working Temperature	-40°C ~ +60°C
Output Impedance (Connected to STB)	75Ω
Output Connector	F-type (female)



MUL-TWIN-LNB

www.multicominc.com

Multicom, Inc.
Ph: 407-331-7779
800-423-2594

Email: multicom@multicominc.com



Quad LNB

Product Specifications

Description

Specifically designed for the DTH markets, this LNB provides optimized reception capabilities. This four Port LNB enables the reception of signal from one satellite and its distribution to four set-top boxes and is ready for High-Definition transmissions and provides excellent noise figure performance. Manufactured to the highest industry quality standards and designed to meet strict specifications this LNB is an ideal solution for the satellite broadcast reception across Europe and South America.



Features:

- Low Phase Noise
- Low Noise Figure
- Low Power Consumption
- High Cross Polarization Isolation
- High Frequency Stability

Parameter	Specification
Ports	4
Low Band Input Frequency Range	10.7~11.7 GHz
Low Band Output Frequency Range	950~1950 MHz
Low Band LO Frequency	9.75 GHz
High Band Input Frequency	11.7~12.75 GHz
High Band Output Frequency Range	1100~2150 MHz
High Band LO Frequency	10.6 GHz
Noise Figure	0.5 dB typ.
LO Initial Accuracy	+/- 1.0 MHz max.
LO Temperature Drift	+/- 2.0 MHz max.
Phase Noise @ 10KHz)	-90 dBc/Hz max.
Conversion Gain	60 dB min.
Gain Ripple	+/- 0.50 dB/36 MHz
Gain Variation	+/- 4 dB
Image Rejection	50 dB min.
1 dB Compression Point @ Output	0.0 dBm min.
Cross Talk	23 dB min.
Control Signals Ca (V)	11.0~14.0 V
Control Signals Cb (H)	16.0~20.0 V
Control Signals Cc (Band Switching)	22 KHz +/- 4 KHz
Output VSWR	2.5 : 1
Radiated Interference	-50 dBm max.
DC Power	130mA max.
Working Temperature	-40°C ~ +60°C
Output Impedance (Connected to STB)	75Ω
Output Connector	F-type (female)



MUL-QUAD-LNB

www.multicominc.com

Multicom, Inc.
Ph: 407-331-7779
800-423-2594

Email: multicom@multicominc.com



Octo LNB

Product Specifications

Description

Specifically designed for the DTH markets, this LNB provides optimized reception capabilities. This eight Port LNB enables the reception of signal from one satellite and its distribution to eight set-top boxes and is ready for High-Definition transmissions and provides excellent noise figure performance. Manufactured to the highest industry quality standards and designed to meet strict specifications this LNB is an ideal solution for the satellite broadcast reception across Europe and South America.



Features:

- Low Phase Noise
- Low Noise Figure
- Low Power Consumption
- High Cross Polarization Isolation
- High Frequency Stability

Parameter	Specification
Ports	8
Low Band Input Frequency Range	10.7~11.7 GHz
Low Band Output Frequency Range	950~1950 MHz
Low Band LO Frequency	9.75 GHz
High Band Input Frequency	11.7~12.75 GHz
High Band Output Frequency Range	1100~2150 MHz
High Band LO Frequency	10.6 GHz
Noise Figure	0.5 dB typ.
LO Initial Accuracy	+/- 1.0 MHz max.
LO Temperature Drift	+/- 2.0 MHz max.
Phase Noise @ 10KHz)	-90 dBc/Hz max.
Conversion Gain	60 dB min.
Gain Ripple	+/- 0.50 dB/36 MHz
Gain Variation	+/- 4 dB
Image Rejection	50 dB min.
1 dB Compression Point @ Output	0.0 dBm min.
Cross Talk	23 dB min.
Control Signals Ca (V)	11.0~14.0 V
Control Signals Cb (H)	16.0~20.0 V
Control Signals Cc (Band Switching)	22 KHz +/- 4 KHz
Output VSWR	2.5 : 1
Radiated Interference	-50 dBm max.
DC Power	130mA max.
Working Temperature	-40°C ~ +60°C
Output Impedance (Connected to STB)	75Ω
Output Connector	F-type (female)



MUL-OCTO-LNB

www.multicominc.com

Multicom, Inc.
Ph: 407-331-7779
800-423-2594

Email: multicom@multicominc.com

SECTION E

INDOOR PRODUCTS	PAGE
AMPLIFIERS	
• FORWARD ONLY	83
• FORWARD WITH ACTIVE RETURN	84
AC POWER ADAPTERS	85
CABLE MODEMS (REFURBISHED)	90
HDMI CABLES	91
RCA AUDIO / VIDEO PATCHCORDS	92

BACK TO MAIN TABLE OF CONTENTS



Indoor Distribution Amplifier

Key Features

- Broadband 40-860 MHz frequency range 40 dB gain for optimal carrier-to-noise ratio and superior picture quality
- +1.0 dB flatness across band provides low distortion and excellent frequency response
- Employs hybrid push-pull module design for distortion-free audio-video quality
- Built in adjustable slope and gain controls for easy system balancing
- Easy-access controls and low loss (-20dB) test point enable simplified setup and performance monitoring
- Shielded enclosure provides RFI shielding performance to reduce leakage and ingress
- Aluminum chassis provides maximum heat dissipation for improved reliability and corrosion resistance



Specification:	Value:
Bandwidth:	40-860 MHz
Forward Gain:	40dB
Maximum Output @ 135 Channel Loading:	50dBmV
Gain Adjust Range:	0-20dB
Slope Adjust Range:	0-20dB
Flatness:	+ 1dB
Noise Figure:	6dB
Connectors:	F-Type Female
CSO (Composite Second Order):	56dB
CTB (Composite Triple Beat):	56dB
Return Loss In:	<12dB
Return Loss Out:	<12dB
Test Points:	-20dB
Power Input:	110 V AC, 60 Hz, 8 W
Operating Temperature:	14° F to 122° F (-10° C to +50° C)
Dimensions:	9" x 3" x 5" (23 x 7 x 12 cm)
Weight:	2.5 Lbs. (1.1 Kg)

Description

The MCA-40860 is a superior quality push-pull wall-mounted distribution amplifier producing signals with low-noise and harmonic distortion. The MCA-40860 serves as an ideal distribution system amplifier for heavily loaded MDU (multi-dwelling units, i.e. apartment complexes), commercial areas, educational institutions, hotels, and broadband CATV or SMATV systems. The distribution amplifier is capable of broadband 135-channel operation over the 40-860 MHz range.

The MCA-40860 is housed in compact, aluminum chassis that provides excellent heat dissipation and allows the amplifier to be operated at high ambient temperatures with no degradation of performance or reliability.

MCA-40860

Frequency
Gain - 40dB

www.multicominc.com

Multicom, Inc.
Ph: 800-423-2594 | 407-331-7779

Fax: 407-339-0204

Email: multicom@multicominc.com



Forward and Reverse Distribution Amplifier

Key Features

- Forward Frequency: 54-860 MHz
- Reverse Frequency: 5-42MHz
- Forward Gain: 30dB
- Reverse Gain: 20dB
- Extremely low distortion and harmonic content
- Suitable for HDTV, CATV, Off-air analog and digital RF distribution applications
- Continuously adjustable equalizer and gain control

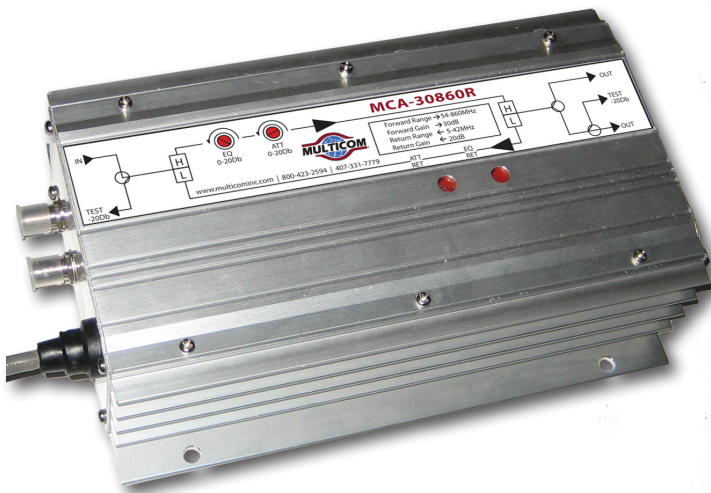

Specification:	Value:
Forward Frequency:	54 - 860 MHz
Forward Gain:	30 ±1.5dB
Maximum Output @ 135 Channel Loading:	2 Outputs @ 50dBmV
Frequency Response:	±0.75dB
Forward Noise Figure:	<6dB
Passband Flatness:	+ 1dB
Gain Adjust Range:	0 - 20dB
Slope Adjust Range:	0 - 20dB
Input Return Loss:	≥15dB
Output Return Loss:	≥15dB
Reverse Frequency:	5 - 42MHz
Reverse Gain:	20 ±1.5dB
Reverse Noise Figure:	< 8dB
Input and Output Impedence:	75 Ohms
In/Output & Test Points Connectors:	F-Type Female
Test Points:	-20dB
Power Input:	110 V AC, 60 Hz, 8 W, 1A AC Fuse (Internal)
Operating Temperature:	14° F to 122° F (-10° C to +50° C)
Dimensions:	9" x 5.5" x 2.5" (23cm x 14cm x 6.5cm)
Weight:	2.2 Lbs. (1 Kg)

Description

The MCA-30860R has been specifically designed for use in multi-dwelling environments such as hospitals, apartment complexes and hotels. This high-gain unit has a bandwidth of 860MHz, allowing effective transmission of large volumes of data within the CATV network. The built-in equalizer and attenuator allow for increased flexibility and easy adjustment of the signal output.

MCA-30860R

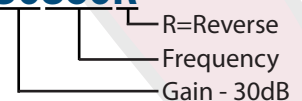

www.multicominc.com

Multicom, Inc.
Ph: 800-423-2594 | 407-331-7779

Fax: 407-339-0204

Email: multicom@multicominc.com



AC Power Adapter

M-CPE-12-200-F-W-US

Key Features

- » Universal Input: 100-240VAC 50/60Hz
- » Highly efficient with low power consumption
- » Short-circuit protection and auto-recovery
- » Over-current protection and auto-recovery
- » Over-voltage protection and auto-recovery
- » Lightweight and compact
- » Wall mount



Specifications	Description	Notes
Input Characteristics		
AC input voltage	100-240VAC	Variable to 90-264VAC
AC input current	0.6A	
AC frequency	50/60 Hz	Variable to 47/63 Hz
AC Plug type	US	Wall
Output Characteristics		
Voltage	12VDC	
Rated Load	2A	
Output power	24W	
Power cord	22AWG	UL2468
Power cord length (DC)	1000mm	39 Inches
Output power plug	5.5 x 2.5 x 11mm barrel	DC power plug
Polarity	Center positive	⊖ ⊕
Environmental		
Operating temperature	0 to 40°C	32 to 104°F
Storage temperature	-10 to 80°C	14 to 176°F
Humidity	20 to 80%	@ 0 to 40°C
Dimensions	78L x 45.5W x 31H	mm
Compliance	EMI, UL, RoHS, CE, REACH	Indoor use only

Description

The Multicom wall mount **M-CPE-12-200-F-W-US** provides 12 volts of DC power, up to 2 amps, to devices that require low voltage direct current.

M-CPE-12-200-G-W-US Part# Matrix Sample

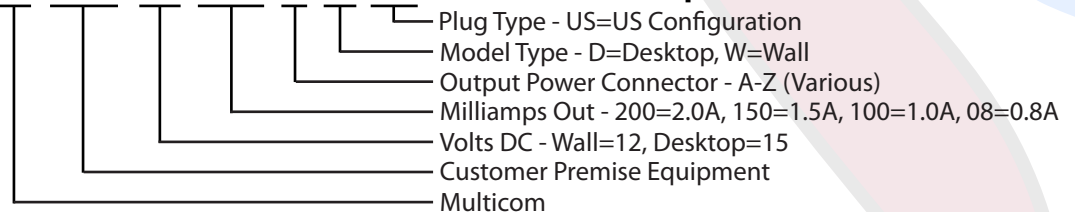

www.multicominc.com

Multicom, Inc.
Ph: 800-423-2594
Fax: 407-339-0204

Email: multicom@multicominc.com



AC Power Adapter

M-CPE-12-200-G-W-US

Key Features

- » Universal Input: 100-240VAC 50/60Hz
- » Highly efficient with low power consumption
- » Short-circuit protection and auto-recovery
- » Over-current protection and auto-recovery
- » Over-voltage protection and auto-recovery
- » Lightweight and compact
- » Wall mount



Specifications	Description	Notes
Input Characteristics		
AC input voltage	100-240VAC	Variable to 90-264VAC
AC input current	0.6A	
AC frequency	50/60 Hz	Variable to 47/63 Hz
AC Plug type	US	Wall
Output Characteristics		
Voltage	12VDC	
Rated Load	2A	
Output power	24W	
Power cord	22AWG	UL2468
Power cord length (DC)	1000mm	39 Inches
Output power plug	5.5 x 2.1 x 11mm barrel	DC power plug
Polarity	Center positive	⊖ ⊕
Environmental		
Operating temperature	0 to 40°C	32 to 104°F
Storage temperature	-10 to 80°C	14 to 176°F
Humidity	20 to 80%	@ 0 to 40°C
Dimensions	78L x 45.5W x 31H	mm
Compliance	EMI, UL, RoHS, CE, REACH	Indoor use only

Description

The Multicom wall mount **M-CPE-12-200-G-W-US** provides 12 volts of DC power, up to 2 amps, to devices that require low voltage direct current.

M-CPE-12-200-G-W-US Part# Matrix Sample

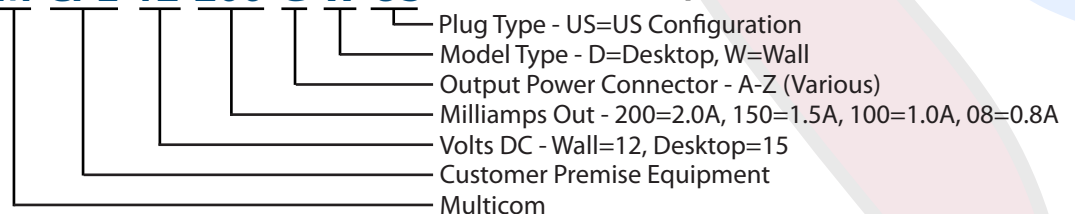

www.multicominc.com

Multicom, Inc.
Ph: 800-423-2594
Fax: 407-339-0204
Email: multicom@multicominc.com



AC Power Adapter

M-CPE-12-270-E-D-US

Key Features

- » Universal Input: 100-240VAC 50/60Hz
- » Highly efficient with low power consumption
- » Short-circuit protection and auto-recovery
- » Over-current protection and auto-recovery
- » Over-voltage protection and auto-recovery
- » Lightweight and compact
- » Desktop

Specifications	Description	Notes
Input Characteristics		
AC input voltage	100-240VAC	Variable to 90-264VAC
AC input current	0.85A	
AC frequency	50/60 Hz	Variable to 47/63 Hz
AC Plug type	US	Desktop
Output Characteristics		
Voltage	12VDC	
Rated Load	2.7A	
Output power	32.4W	
Power cord	22AWG	UL2468
Power cord length (AC)	1000mm	39 Inches
Power cord length (DC)	1000mm	39 Inches
Output power plug	5.5 x 2.1 x 9.5mm barrel	DC power plug
Polarity	Center positive	⊖ ⊕ ⊕
Environmental		
Operating temperature	0 to 40°C	32 to 104°F
Storage temperature	-10 to 80°C	14 to 176°F
Humidity	25 to 75%	@ 0 to 40°C
Dimensions	105L x 45W x 28H	mm
Compliance	EMI, UL, RoHS, CE, REACH	Indoor use only



Description

The Multicom wall mount **M-CPE-12-270-E-D-US** provides 12 volts of DC power, up to 2.7 amps, to devices that require low voltage direct current.

M-CPE-12-200-G-W-US Part# Matrix Sample

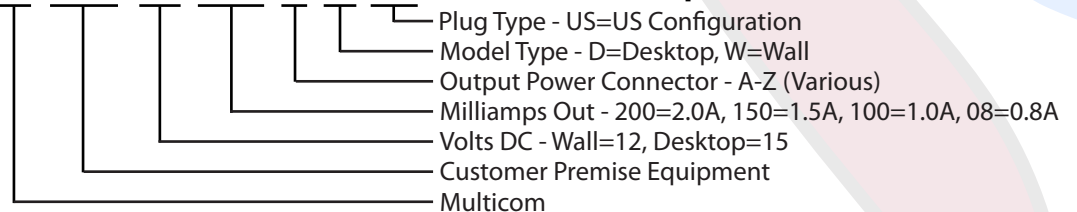

www.multicominc.com

Multicom, Inc.
Ph: 800-423-2594
Fax: 407-339-0204
Email: multicom@multicominc.com



AC Power Adapter

M-CPE-12-300-E-D-US

Key Features

- » Universal Input: 100-240VAC 50/60Hz
- » Highly efficient with low power consumption
- » Short-circuit protection and auto-recovery
- » Over-current protection and auto-recovery
- » Over-voltage protection and auto-recovery
- » Lightweight and compact
- » Desktop

Specifications	Description	Notes
Input Characteristics		
AC input voltage	100-240VAC	Variable to 90-264VAC
AC input current	0.9A	
AC frequency	50/60 Hz	Variable to 47/63 Hz
AC Plug type	US	Desktop
Output Characteristics		
Voltage	12VDC	
Rated Load	3A	
Output power	36W	
Power cord	22AWG	UL2468
Power cord length (AC)	1000mm	39 Inches
Power cord length (DC)	1000mm	39 Inches
Output power plug	5.5 x 2.1 x 9.5mm barrel	DC power plug
Polarity	Center positive	⊖ ⊕
Environmental		
Operating temperature	0 to 40°C	32 to 104°F
Storage temperature	-10 to 80°C	14 to 176°F
Humidity	25 to 75%	@ 0 to 40°C
Dimensions	105L x 45W x 28H	mm
Compliance	EMI, UL, RoHS, CE, REACH	Indoor use only



Description

The Multicom wall mount **M-CPE-12-300-E-D-US** provides 12 volts of DC power, up to 3 amps, to devices that require low voltage direct current.

M-CPE-12-200-G-W-US Part# Matrix Sample

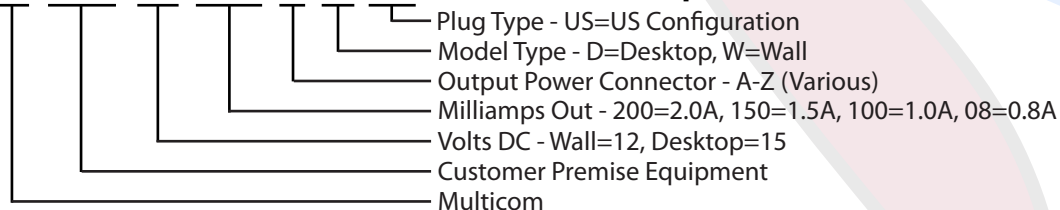

www.multicominc.com

Multicom, Inc.
Ph: 800-423-2594
Fax: 407-339-0204
Email: multicom@multicominc.com



AC Power Adapter

M-CPE-15-130-D-D-US

Key Features

- » Universal Input: 100-240VAC 50/60Hz
- » Highly efficient with low power consumption
- » Short-circuit protection and auto-recovery
- » Over-current protection and auto-recovery
- » Over-voltage protection and auto-recovery
- » Lightweight and compact
- » Desktop

Specifications	Description	Notes
Input Characteristics		
AC input voltage	100-240VAC	Variable to 90-264VAC
AC input current	0.5A	
AC frequency	50/60 Hz	Variable to 47/63 Hz
AC Plug type	US	Desktop
Output Characteristics		
Voltage	15VDC	
Rated Load	1.3A	
Output power	19.5W	
Power cord	24AWG	UL2468
Power cord length (AC)	1000mm	39 Inches
Power cord length (DC)	1000mm	39 Inches
Output power plug	5.5 x 2.0 x 8.5mm (min) barrel	DC power plug
Polarity	Center positive	⊖ ⊕
Environmental		
Operating temperature	0 to 40°C	32 to 104°F
Storage temperature	-10 to 80°C	14 to 176°F
Humidity	5 to 90%	@ 0 to 40°C
Dimensions	88L x 39W x 28H	mm
Compliance	EMI, UL, RoHS, CE, REACH	Indoor use only



Description

The Multicom wall mount **M-CPE-15-130-D-D-US** provides 15 volts of DC power, up to 1.3 amps, to devices that require low voltage direct current.

M-CPE-12-200-G-W-US Part# Matrix

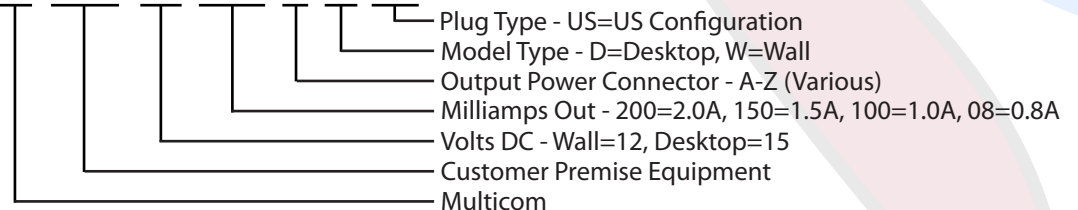

www.multicominc.com

Multicom, Inc.
Ph: 800-423-2594
Fax: 407-339-0204
Email: multicom@multicominc.com



Refurbished Cable Modems

Product Specifications

Multicom markets a wide variety of refurbished Cable Modems with an enhanced quality selection to meet your needs:

➔ **FIELD PULLED**

Sold 'as is' for the best price, and shipped in bulk

➔ **REFURBISHED & TESTED**

Tested and certified by Multicom technicians to be in perfect working order, and shipped in bulk

➔ **REFURBISHED, TESTED & BOXED**

Tested and certified by Multicom technicians to be in perfect working order, and individually boxed

Multicom represents these premium manufacturers, and many more:



Many refurbished modems include these premium features:

- DOCSIS 2.0
- DOCSIS 3.0
- WiFi
- Gateways

www.multicominc.com

Multicom, Inc.
Ph: 800-423-2594
Fax: 407-339-0204
Email: multicom@multicominc.com



High Speed HDMI Cable



Multicom's High Speed HDMI cable provides a reliable, high quality connection between audio and video components such as Blu-ray players, cable and satellite set-top boxes, DVD players, A/V receivers, gaming consoles, and much more.



Featuring a durable molded PVC housing, gold plated contacts and corrosion resistant connectors with V3 shielding, this HDMI cable consistently delivers excellent picture and sound quality for today's discriminating A/V enthusiasts.

Features:

- Supports high definition 1080p, Adobe RGB Color, Deep Color, 3D, sYCC601 Color, and Adobe YCC601 to accurately display natural, vivid colors
- Supports Dolby Digital, DTS, Dolby True HD, DTS-HD MasterAudio, Audio Return Channel and Lip Sync to deliver the highest quality and duplication of sound
- Compatible with the lossless compressed digital audio formats

SPECIFICATIONS

Connector Type	HDMI Male A to HDMI Male A
Wire Gauge	30 AWG
Conductors	Solid Copper
Bandwidth	10.2 Gbps
Connector Housing Material	Moulded PVC, Black
Jacket	PVC, Black
Connector Finish	Nickel Plated
Connector Contacts	Gold Plated
Shielding Level	Triple
Shielding Type	Aluminum-Mylar
Ethernet Channel	No
HDMI Connector Head Size (mm)	36.24L x 20.54W x 11.27H
HDMI Cable Diameter	6mm

COMPLIANCE ALL COMPONENTS ARE RoHS COMPLIANT



Part# MUL-HDMI 1.3-1.5M-MA-MA-HS-30

A B C D E F

- A** - Cable Type: HDMI 1.3, 1.4
- B** - Cable Length: M=Meters, FT=Feet
- C** - Conn #1: M=Male, F=Female; Type: A,B,C...
- D** - Conn #2: M=Male, F=Female; Type: A,B,C...
- E** - Speed: STD=Standard, HS=High Speed
- F** - Wire Gauge: AWG

www.multicominc.com

Ph: 407-331-7779

800-423-2594

multicom@multicominc.com



RCA Audio/Video Patchcord

Description

Multicom's high quality RCA Audio/Video Patchcord provides a reliable, high quality connection between audio and video components such as cable and satellite set-top boxes, DVD players, A/V receivers, gaming consoles, and much more.

Featuring a durable molded PVC housing, nickel-plated copper corrosion resistant connectors, this RCA patchcord consistently delivers excellent picture and sound quality for today's discriminating A/V enthusiasts.



SPECIFICATIONS

Connector Type	RCA Male, side A and side B
Connector Finish	Nickel Plated Copper
Conductors	Stranded, 10 x .10mm CCS
Shielding	28 x .10mm CCS
Connector Housing Material	Molded PVC, Red, White, Yellow
Number of Conductors	3
Length	1.5 Meters (5 Feet)
Cable Jacket	PVC, Black
Connector Finish	Nickel Plated Copper
Attenuation (at 10MHz)	0.047 dB/m (max)
Operating Temperature Range	0 to 70°C (32 to 158°F)

COMPLIANCE

ALL COMPONENTS ARE ISO 9001 and RoHS COMPLIANT



MUL-RCA-3-1.5M-M-M-2.7-NI (pictured above)

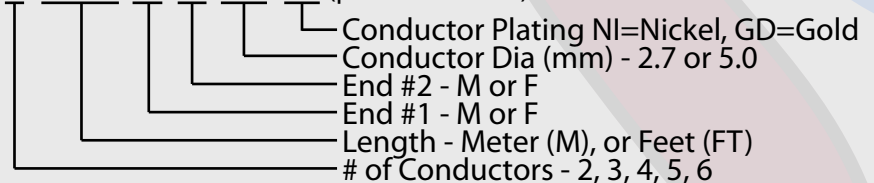

Part# MUL-RCA-3-1.5M-M-M-2.7-NI

www.multicominc.com

Ph: 407-331-7779

800-423-2594

multicom@multicominc.com

SECTION F

IT/ DATA PRODUCTS	PAGE
SFPs	
• SFP	94
• SFP+	
MEDIA CONVERTER	95

[BACK TO MAIN TABLE OF CONTENTS](#)



Small Form Factor Pluggable (SFP) Optical Transceiver Modules

Multicom SFP Optical Transceiver Modules give you a wide variety of Ethernet connectivity options for data center, enterprise wiring closet, and service provider transport applications. Multicom stocks a diverse range of industry-compliant SFP modules in the configuration you need for Ethernet deployments in any networking environment.

Key Features:

- Industry's smallest 10G form factor for greatest density per chassis
- Hot-swappable input/output device that plugs into an Ethernet SFP port of a any compatible switch (no need to power down if installing or replacing)
- Supports "pay-as-you-populate" model for investment protection and ease of technology upgrading and migration
- Digital optical monitoring capability for strong diagnostic capabilities
- Optical interoperability with 10GBASE XENPAK, 10GBASE X2, and 10GBASE XFP interfaces on the same link

Applications:

- Fast Ethernet
- SDH/SONET
- ATM Switches and Routers
- Other Optical Links

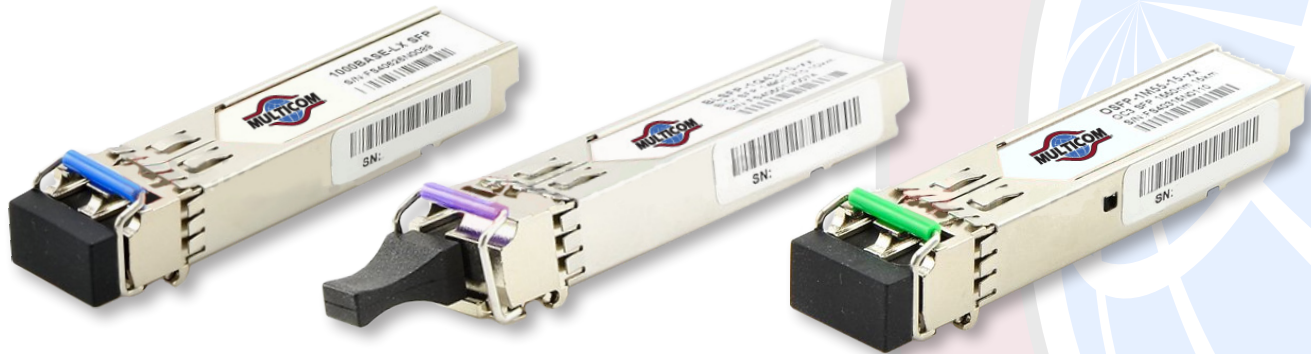

The Multicom Part#s below represent the majority of SFP configurations. However additional variations are available including connector type, transmission distance and manufacturer-specific SFPs.

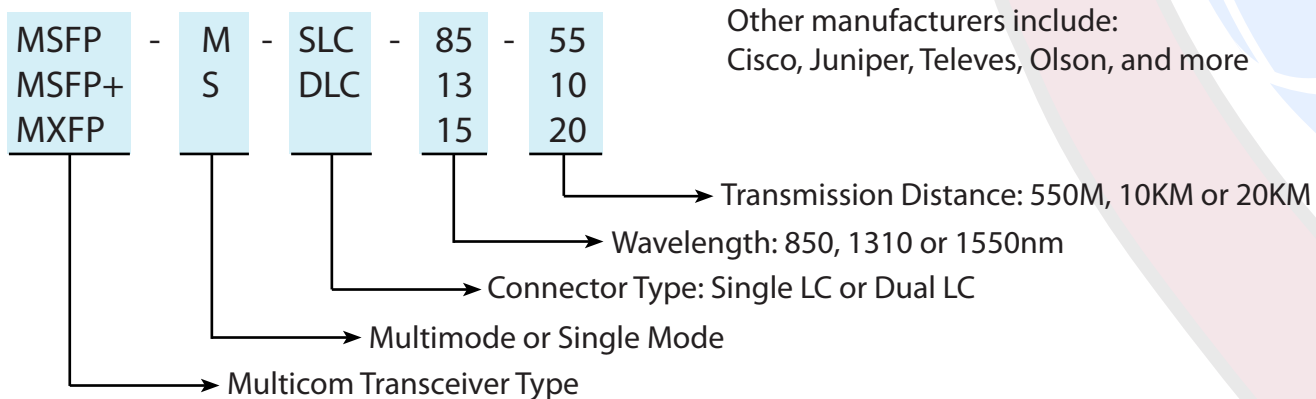

Example: MSFP-S-DLC-13-10 is a Single Mode, Dual LC Connector SFP with 1310nm wavelength going up to 10KM

www.multicominc.com

Multicom, Inc.
Ph: 800-423-2594
Fax: 407-339-0204
Email: multicom@multicominc.com



Fiber Media Converter

Key Features

- Extends traditional Ethernet networks over long distances via fiber optics
- 10/100/1000Mb Ethernet speeds
- LED status display
- Power supply included
- Dual and single fiber available



Description

Fiber media converters are simple networking devices that make it possible to connect two dissimilar media types such as twisted pair copper cables with fiber optic cabling. Media converters are useful in extending the reach of the conventional 10Mb, 100Mb and 1,000Mb LANs up to 80 Kms. to form one large "campus area network". They are a high performance, cost effective and flexible solution for a wide range of applications in a LAN network.

MMC-SM-100-25-DF-SC-1310

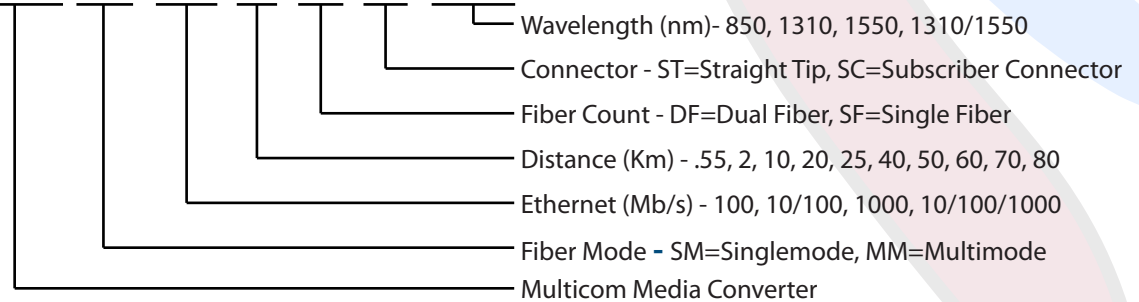

www.multicominc.com

Multicom, Inc.
1076 Florida Central Parkway
Longwood, FL 32750
Ph: 800-423-2594 / 407-331-7779
Fax: 407-339-0204
Email: multicom@multicominc.com

SECTION G

TOOLS & TEST EQUIPMENT	PAGE
FUSION SPLICER	97
OPTICAL TIME DOMAIN REFLECTOMETER	99

[BACK TO MAIN TABLE OF CONTENTS](#)



Fiber Optic Fusion Splicer

Features

- State-of-the-art core-to-core fiber Profile Alignment System (PAS)
- Fully-automatic, semi-automatic and manual operating modes
- Automatic detection of fiber cleaved face quality
- Automatic display of cleaved fiber and the offset angles
- Automatic analysis and estimation of splice loss
- Automatic detection of bad/faulty splice
- Automatic detailed data report record and memory storage for each splice (up to 2,000 splices)
- Automated 2N splice tension test
- Handy, easy-to-carry, solid and durable with shock-resistant design
- Enhanced windproof fusion area cover
- Color HD 5.1" LCD and graphical interface
- English or Spanish language, user-selectable
- Single X or Y view, or X and Y simultaneously
- High quality electrodes with up to 5,000 splicing cycles
- Easy user-replaceable electrodes design (set of spares is included)
- Wide range of fusion and heating parameter defaults and options
- Built-in temperature, humidity, and air pressure sensors
- Intelligent power indicator and auto power-off
- Built-in heat shrink heater: Easy to use, quick, customizable parameters
- Data reports can be downloaded to PC and system upgrades can be uploaded via USB port and cable
- Built-in work lights make optical-fiber placement easier and more accurate, even at night or in dark work areas
- High precision 6 motor drive design

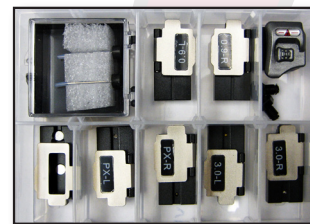

Fiber Optic Fixture/Clamp Set

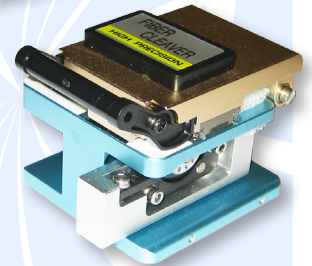

Precision Optical Cleaver

Description

The Multicom MUL-FSPlice-100 Fiber Optic Fusion Splicer employs high-speed image processing technology and special positioning technology, allowing the total process of fusion splicing to be finished within 8 to 10 seconds. The large-screen LCD clearly demonstrates every stage of optical-fiber fusion splicing process as it occurs and allows for high magnification inspection and quality assessment by the operator.

The Fusion Splicer is compact in size, lightweight, and is ideal to work just about anywhere, including outdoor environments and remote worksites.

Fiber Optic Fusion Splicer Kit Includes:

- | | |
|---|----------------------------|
| • MUL-FSPlice-100 Fiber Optic Fusion Splicer | • Cotton "Q-tip" pack |
| • Fiber optic cable/fiber/connector fixture-clamp sets for FTTH, PON: .9, 3.0, PX, SC connector | • AC Adapter |
| • Heatshrink Connector Fixture-Clamp | • Spare Electrodes |
| • Precision Optical Fiber Cleaver and case | • Heat Shrink Cooling Tray |
| • Fiber Stripper | • Heavy Duty Carrying Case |
| • Tweezers | • Operating Manual |
| • Alcohol bottle with dab-action auto-closing top (empty) | |
| • USB Thumb Drive with manual, USB PC drivers, splice file viewer | |



Fusion Splicer, Cleaver and all Accessories come in a Heavy Duty Carrying Case

MUL-FSPlice-100

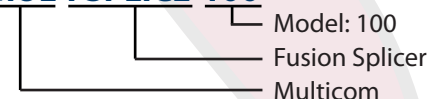

www.multicominc.com

Multicom, Inc.
Ph: 800-423-2594
Fax: 407-339-0204

Email: multicom@multicominc.com



Fiber Optic Fusion Splicer

Product Specifications

Description

The Multicom MUL-FSPLICE-100 Fiber Optic Fusion Splicer employs high-speed image processing technology and special positioning technology, allowing the total process of fusion splicing to be finished within 8 to 10 seconds. The splicer is compact in size, lightweight, and is ideal to work just about anywhere including outdoor environments, dark and remote worksites.

Technical Specifications

Parameter	Specification
Applications	SM (Singlemode - ITU-T G.652), MM (Multi-mode - ITU-T G.651), DS (Dispersion displacement, ITU-T G.653, NZDS (Non-zero dispersion displacement, ITU-T G.655)
Splice loss	0.02dB (SM), 0.01 dB (MM), 0.04dB (DS), 0.04dB (NZDS)
Return loss	> 60dB
Operation mode	Full auto, semi-auto, manual
Average splicing time	8 - 10 seconds
Average heating time	36 seconds
Fiber aligning method	Core, clad, manual alignment
Fiber diameter	Cladding diameter: 80 ~ 150µm, coating diameter: 100 ~ 1000µm
Fiber cleaved length	10 ~ 16mm (coating diameter <250µm), 16mm (coating diameter: 250 ~ 1000µm)
Lens magnification	Vertical double display: 310x, horizontal double display: 155x
Display	High Definition 5.1 inch, 640 x 480 LCD
Tension test	Standard 2N (option in unit settings)
Heat shrinkable tube	60mm, 40mm and other micro-heat shrinkable tube
Battery capacity splice-heat cycles	400 typical
Battery full charge time	3 hours - unit is able to operate/splice during charging process
Battery life	300 ~ 500 charging cycles
Power display	Real-time remaining power is displayed on screen
Electrode life	5000 splice cycles typical, easily replaceable electrodes (included)
Optical fiber fixture/clamp	Included assortment of fiber clamps allows for accurate optical fiber positioning
Construction lighting	Extra bright wide angle light for splicing at low lighting levels or night
External ports	USB
Power Supply	Built-in 11.8V lithium battery External AC adapter: Input AC 100-240V, Output: DC 12.6V/5.0A
Operating conditions	-10 ~ 50°C (14 ~ 122°F), 95% no condensation, 0 ~ 5000m above sea level
Dimensions	169mm L x 152mm W x 155mm H
Weight	2.4kg (5.3lb) without battery, 2.9kg (6.4lb) with battery

MUL-FSPLICE-100

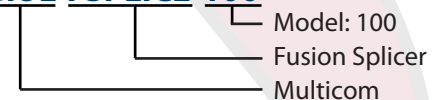

www.multicominc.com

Multicom, Inc.

Ph: 800-423-2594 / 407-331-7779

Fax: 407-339-0204

Email: multicom@multicominc.com



Optical Time Domain Reflectometer

Description

The Multicom MUL-OTDR-200 OTDR handheld Optical Time Domain Reflectometer is a new generation of intelligent optical-fiber test equipment. It is widely used in the construction, maintenance, measurement, and emergency repair of optical-fiber communication systems networks as well as the development, manufacturing and measurement of optical fibers and optical cables.

The OTDR is able to Measure and Display:

- Length of optical fiber
- Distance between any two points in the curves of optical fiber
- Loss between any two points in the curves (dB)
- Connecting loss at the joints of the curves
- Value of reflection loss
- Distance between two event points
- Loss between two event points
- Average loss between two event points
- Waveform storage

The OTDR is also able to:

- Identify the connecting fault and disconnecting locations of optical fibers and optical cables
- Indicate the power level of intelligent batteries
- Work as a real-time measurement instrument, this increases the convenience on observing real-time connecting effects/events of optical fibers



Additional Features

- Graphical window operating interface
- VFL (Visual Fault Location) function
- Color LCD display
- Handheld device, light, easy to carry, solid and durable
- Intelligent battery power indicator & auto power-off at low voltage
- Able to transfer data to PC via USB cable

MUL-OTDR-200

- Model: 200, 300
- Optical Time Domain Reflectometer
- Multicom

www.multicominc.com

Multicom, Inc.
Ph: 800-423-2594
Fax: 407-339-0204
Email: multicom@multicominc.com



Optical Time Domain Reflectometer

Product Specifications

Features

- Graphical window operating interface
- VFL (Visual Fault Location) function
- Color LCD display
- Handheld device, light, easy to carry, solid and durable
- Intelligent battery power indicator and auto power-off at low voltage
- Able to transfer data to PC via USB cable

Technical Specifications

Parameter	MUL-OTDR-200	MUL-OTDR-300
Wavelength	1310/1550nm ±20nm	1310/1550nm ±20nm
Type of compatible applicable fibers	Singlemode	Singlemode
Dynamic Range	15/16dB (40-50km)	30/32dB (100-110km)
Minimum event deadzone	1.6m (singlemode)	
Ranging accuracy	±(1m + sampling interval + 0.003% x distance), (excluding refractive index imbedding error)	
Resolution of ranging	12 - 16m	
Loss threshold value	0.01dB	
Linearity	0.05dB/dB	
VFL output power	5mW	
Measurement range	4, 8, 16, 32, 48, 64, 128, 256km (singlemode)	
Pulse width	10, 30, 80, 160, 320, 640, 1280, 2560, 10240ns	
Number of sampling points	65K	
Waveform storage capacity	1,000 frames	
Range of refractive index	1.00000 ~ 2.00000	
Range of optical-cable correction factor	0.800000 ~ 1.00000	
LCD display	640 x 480, 5.1" color	
Port	USB	
Optical output port	FC/PC	
Power supply	AC/DC adapter AC input: 100V ~ 240V (1.5A) Output DC: 9V (2A) Power frequency: 50Hz ~ 60Hz Internal lithium battery: 7.4V, 4400mAh Working battery life: 10 hours @ normal temperature	
Menu language	English	
Storage Temperature	-40 ~ 70°C (-40 ~ 158°F) exclusive of battery	
Relative humidity	5-95%, no condensation	
Dimensions	215mm L x 130mm H x 66mm W	
Weight	~ 1kg (~2.2 lbs)	

MUL-OTDR-200

Model: 200, 300
Optical Time Domain Reflectometer
Multicom

www.multicominc.com

Multicom, Inc.
Ph: 800-423-2594 / 407-331-7779

Fax: 407-339-0204

Email: multicom@multicominc.com