

SIEMENS



RUGGEDCOM Multi-Service Platform

Modular Managed Layer 2 / 3 Ethernet Switches, Routers and Security Appliances

Brochure

Edition
09/2014

Answers for industry.

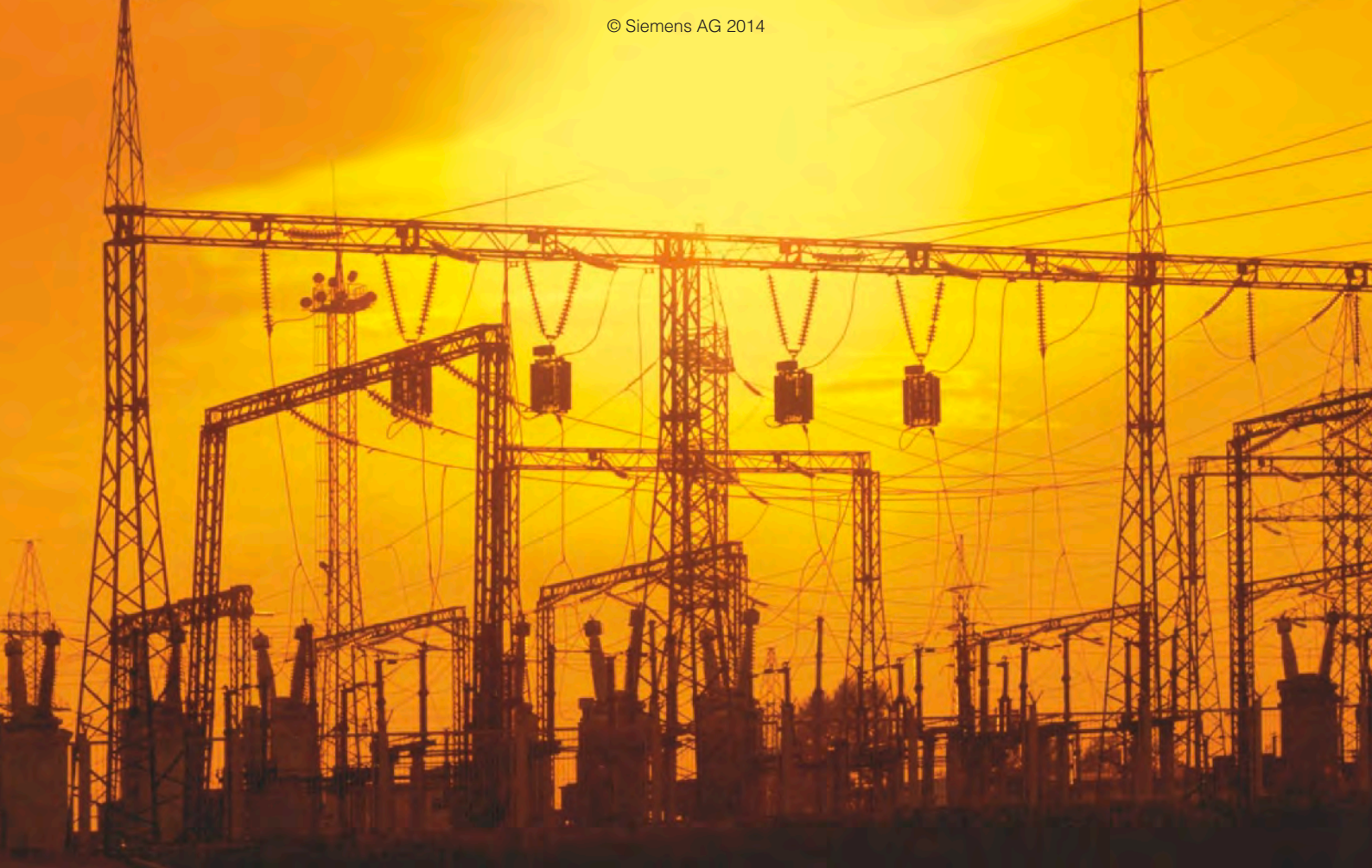

Contents

Common features and benefits	2 – 3
RUGGEDCOM technology	4 – 5
Hardware portfolio	6 – 7
Certification and use cases	8 – 9
Modules	10 – 13
Order options	14 – 15



RUGGEDCOM Multi-Service Platforms

Common Features and Benefits

Lowest total cost of ownership

- No hassle upgrades in the field, and the flexibility to adapt to the changing network

Reliability

- Utility grade reliability designed in from the very beginning
- Current field demonstrated MTBF of 180 years
- Designed as per MIL-HDBK-217F reliability guidelines
- HALT analysis to enhance product robustness

Carrier grade performance

- Layer 2 and layer 3 switching and a rich set of WAN, serial, switching, routing and management features

Immunity

- IEEE 1613 class 2 error-free for substations
- IEC 61850-3 performance for substations
- Class-B emissions for demanding installations

Suitable for all environments

- Certified to several industry standards: power, rail, ITS, and MIL-STD
- Available in various form factors
- Best-in-class warranty, support, and services
- Expandable with external applications, appliances and utilities



RUGGEDCOM technology

Rugged Rated

RUGGEDCOM products have been specifically designed and tested to withstand the demands of the mission-critical environments.

Reliable operation in harsh electrical installations

- IEC 61850-3 and IEEE 1613 (electric power substations)
- IEC 61000-6-2 and IEC 61800-3 (industrial environments)
- NEMA TS-2 (traffic control equipment)
- EN 50121-4 (railway applications)
- EN 50155 (equipment on-board rail vehicles)

Error-free operation in high EMI environments

- Zero Packet Loss technology for fiber-based networking devices
- IEEE 1613 class 2 error-free performance under EMI stress
- Fiber optic ports supporting both short and long haul fiber

Operation in industrial temperature range

- -40°C to +85°C normal operation
- Passive cooling – no fans

High availability

- Integrated single or redundant power supplies
- Universal high-voltage range: 88 – 300 VDC or 85 – 264 VAC
- Low voltage DC: 12 VDC (9 – 15 VDC), 24 VDC (10 – 36 VDC) or 48 VDC (36 – 72 VDC)
- Dual power supplies can be powered independently, from different input voltages

Durable installations

- Full metal enclosure
- Heavy duty mounting
- Industrial terminal blocks for power and I/O connection

Zero Packet Loss

The proliferation of IP networking technology from the office to industrial environments, for use in real-time, mission critical, control applications requires a level of immunity to electromagnetic interference (EMI) well beyond what is currently delivered by commercial grade networking products. In fact, even the EMI immunity requirements prescribed by IEC 61000-6-2 (Generic Standards – Immunity for Industrial Environments) are inadequate for many environments.

One such environment is the electric utility substation, where EMI levels can be significantly higher than those of the generic industrial environment defined in IEC 61000-6-2. In order to address this risk, both the IEC and IEEE have developed and issued new standards addressing EMI immunity requirements for communications networking equipment in electric utility substations.

In response to these requirements, Siemens RUGGEDCOM technology withstands all of the EMI type tests required by IEC 61850-3 without experiencing any communications loss or delays. Products featuring this technology also qualify as IEEE 1613 class 2 error-free devices.

This innovation is known as Zero Packet Loss technology and it is designed to provide the same level of EMI immunity, performance relaying, and reliability as protective relaying devices.

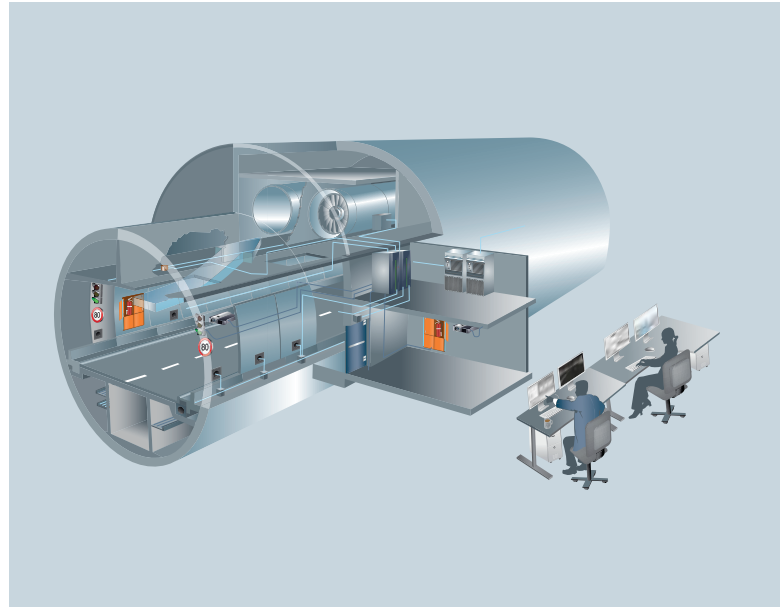
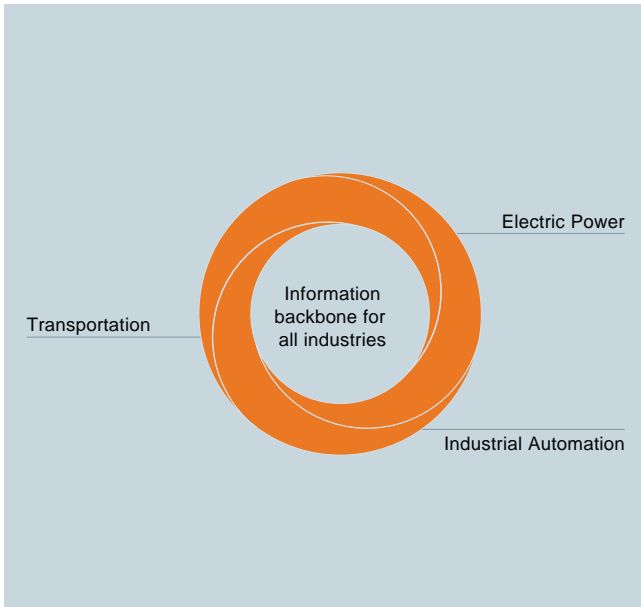

IEC 61850

IEC 61850 standard for communications in substations is composed of ten parts, which outlines a complete framework for substation automation, including EMI (electromagnetic interference), immunity and environmental requirements (IEC 61850-3) for communications networks in substations.

The EMI immunity requirements of IEC 61850-3 are derived from IEC 61000-6-5 (Immunity for Power Station and Substation Environments), which defines a set of potentially destructive EMI type tests designed to simulate both continuous and transient EMI phenomena in the substation.

This standard has a minimum requirement that the networking equipment operates without any physical damage, reset or latch-up during the application of a variety of destructive EMI immunity type tests.

IEEE 1613

IEEE 1613 is an industry standard for communications networking devices in electric power substations. It specifies ratings, environmental performance and testing requirements for communications networking devices installed in electric power substations.

Within the standard, two classes of devices are defined, based on the outcome of a specific set of potentially destructive EMI type tests (EMI stress) designed to simulate EMI phenomena in the substation. These type tests are derived from the same type tests applied to mission critical protective relays (i.e. C37.90.).

Class 1 — these devices are allowed to experience data errors, loss, or delays when exposed to EMI stress.

Class 2 — these devices must provide error-free (i.e. no data errors, delays or loss) operation when exposed to EMI stress.

Neither class of device must experience any permanent damage under EMI stress.

Siemens RUGGEDCOM family qualifies as IEEE 1613 Class 2 error-free devices, putting these products in a class of their own.

Hardware portfolio





			
RUGGEDCOM RX1500	RUGGEDCOM RX1501	RUGGEDCOM RX1510	RUGGEDCOM RX1511
<ul style="list-style-type: none"> 2 redundant power modules 4 slots for line module 	<ul style="list-style-type: none"> 1 power module 6 slots for line modules 	<ul style="list-style-type: none"> 2 redundant power modules 4 slots for line modules 	<ul style="list-style-type: none"> 1 power module 2 slots for line modules

Common features

Management	Layer 2 (switching)	Layer 3 (routing)	Security
Web UI	QoS	MPLS	Integrated firewall
HTTPS	RSTP, eRSTP, MSTP	DHCP	IPSec
SSH	SNTP	VRRPv2 and VRRPv3	VPN
RMON	L2TPv2, L2TPv3	PIM SM	HTTPS
SNMP	Port rate limiting	OSPF	VLANs
CLI	Link backup	BGP	SNMPv3
Remote Syslog	Port mirroring	Traffic prioritization	Port-based access control
Real-time line traces	Broadcast storm filtering	WAN interfaces	MAC-based port security
USB mass-storage		Cellular interfaces	RADIUS
Serial console		IS-IS	Brute Force Attack prevention
			Dead peer detection

Available pluggable transceivers

Type	Part number	Distance	Mode/speed	Wavelength	Connector
SFP	6GK6000-8FE51-0AA0	2 km	100 BaseFX	1310 nm	LC
	6GK6000-8FE52-0AA0	20 km			
	6GK6000-8FE53-0AA0	50 km			
	6GK6000-8FE54-0AA0	90 km			
	6GK6000-8FG51-0AA0	500 m	1000 BaseSX	850 nm	
	6GK6000-8FG52-0AA0	10 km	1000 BaseLX	1310 nm	
	6GK6000-8FG53-0AA0	25 km		1550 nm	
	6GK6000-8FG54-0AA0	70 km		1310 nm TX	
	6GK6000-8FB51-0AA0	10 km		1490 nm RX	
	6GK6000-8FB51-0AA0	40 km	1000 BaseBX	1490 nm TX	
	6GK6000-8FB52-0AA0	10 km		1310 nm RX	
	6GK6000-8FB52-0AA0	40 km			
6GK6000-8FT51-0AA0	10 km	10 G BaseLR		1310 nm	
SFP+	6GK6000-8FT53-0AA0	40 km	10 G BaseER	1550 nm	
	6GK6000-8FT52-0AA0	80 km	10 G BaseZR		

			
RUGGEDCOM RX1512	RUGGEDCOM RX5000	RUGGEDCOM MX5000	RUGGEDCOM MX5000RE
<ul style="list-style-type: none"> Internal DC power supply 2 slots for line modules 	<ul style="list-style-type: none"> 2 redundant power modules 6 slots for line modules 	<ul style="list-style-type: none"> 2 redundant power modules 6 slots for line modules MIL-STD certified 	<ul style="list-style-type: none"> 2 redundant power modules 6 slots for line modules Fan control and alarm unit MIL-STD certified IP65 enclosure

Connectivity

	RX15xx	RX5000	MX5000
Power	Screw terminal / plug terminal	Screw terminal	
10 Gbps	None	SFP+, up to 80 km	
Gigabit	LC, SC, M12 (A, X-coded), RJ45, SFP – up to 70 km	LC, SC, RJ45, SFP – up to 25 km	LC, micro-D, SFP – up to 25 km
Fast Ethernet	LC, SC, ST, MTRJ, RJ45, M12 (D, A, X-coded), SFP – up to 90 km	LC, SC, ST, MTRJ, RJ45, SFP – up to 90 km	LC, ST, micro-D, RJ45 – up to 90 km
APE	RJ45, USB, DVI		
10 FL	ST – up to 2 km		
T1	RJ48 (channelized)		
E1	RJ48, BNC (channelized)		
DDS	RJ48 (56k master/slave, 64k slave)	None	
Cellular	SMA (antennas), 2FF (mini-SIM), GSM, EDGE, HSPA, EVDO (network)		
Serial	RJ45 (RS232, RS422, RS485)		
Chassis	DB9/RJ45 console, RJ45 management, USB	DB9 console, RJ45 management, USB	

Use case: electric power

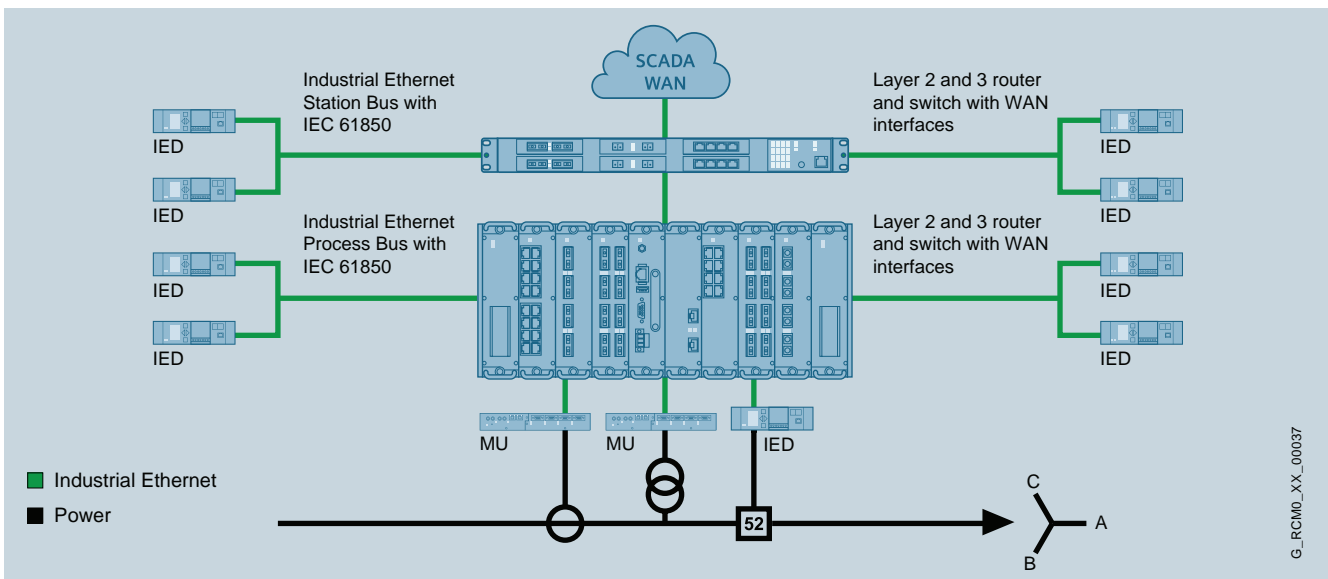

G_RCM0_XX_00037

Certification and use cases

Port density

	RUGGEDCOM RX1500	RUGGEDCOM RX1501	RUGGEDCOM RX1510	RUGGEDCOM RX1511	RUGGEDCOM RX1512	RUGGEDCOM RX5000	RUGGEDCOM MX5000
Power	2	1	2	1	1 (internal)	2	2
10 GigE	None					2	2
Gigabit	8	4	8	4	4	24	24
100 TX	24	36	24	12	12	96	48
100 FX	24	36	24	12	12	48	48
Serial	24	36	24	12	12	48	48
APE	2	2	2	2	1		
10FL	12	18	12	6	6		
T1/E1	4	4	4	4	4	None	
DDS	4	4	4	2	2		
Cellular	8	12	8	4	4		

Use case: traffic management

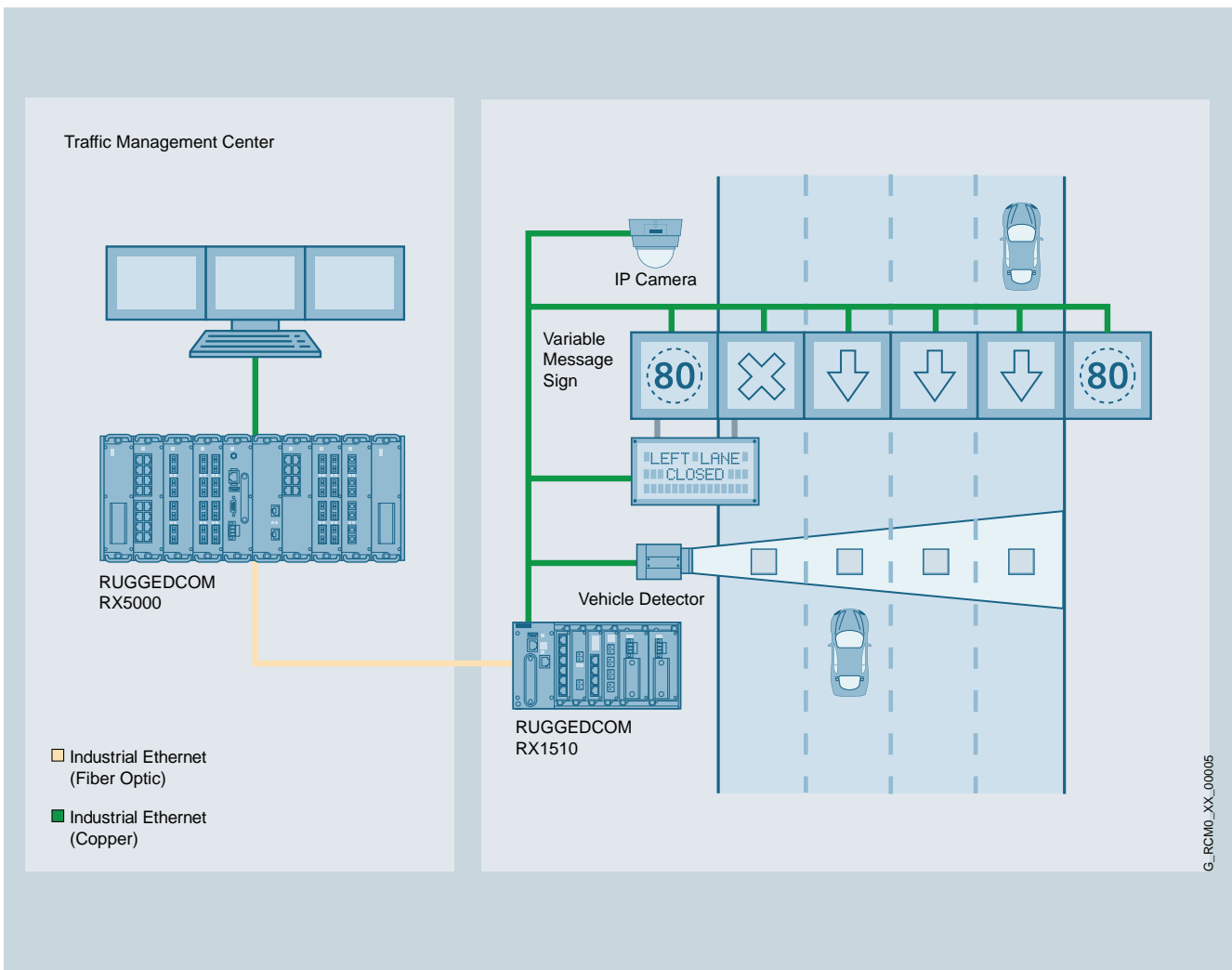

Comprehensive certification

Product	TUV	UL – Siemens	FCC part 15	CISPR22	KEMA (IEC 61850)	Altitude (40,000ft)	Railway EN50155	NTS – EMI	NTS – MWS	DC MAGNET TEST – NAVAL	CE Declaration – Siemens	CCC (China) Waiver	CCC (China) HS Codes	RCM (Australia) – Siemens	KCC(Korea) – Siemens
RUGGEDCOM RX1500	•		•	•	•						•	•	•	•	•
RUGGEDCOM RX1501	•	•	•	•		•	•				•	•	•	•	•
RUGGEDCOM RX1510	•		•	•		•	•				•	•	•	•	•
RUGGEDCOM RX1511	•		•	•							•	•	•	•	•
RUGGEDCOM RX1512	•		•	•							•	•	•	•	•
RUGGEDCOM RX5000	•	•	•	•				•	•	•	•	•	•	•	•
RUGGEDCOM MX5000RE	•		•	•				•	•	•	•				

Use case: railway control

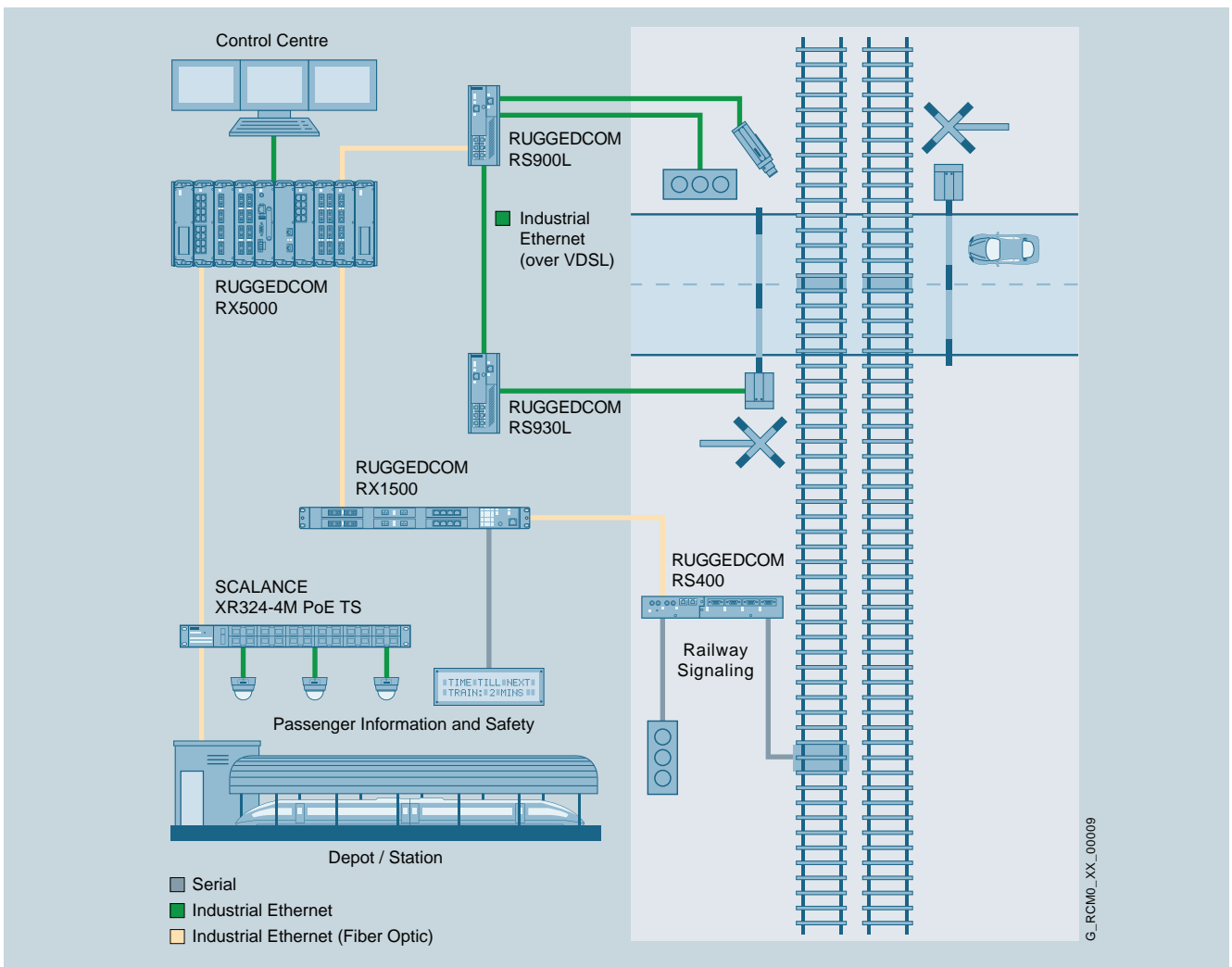

Modules

Hot-swappable RUGGEDCOM RX1500 modules

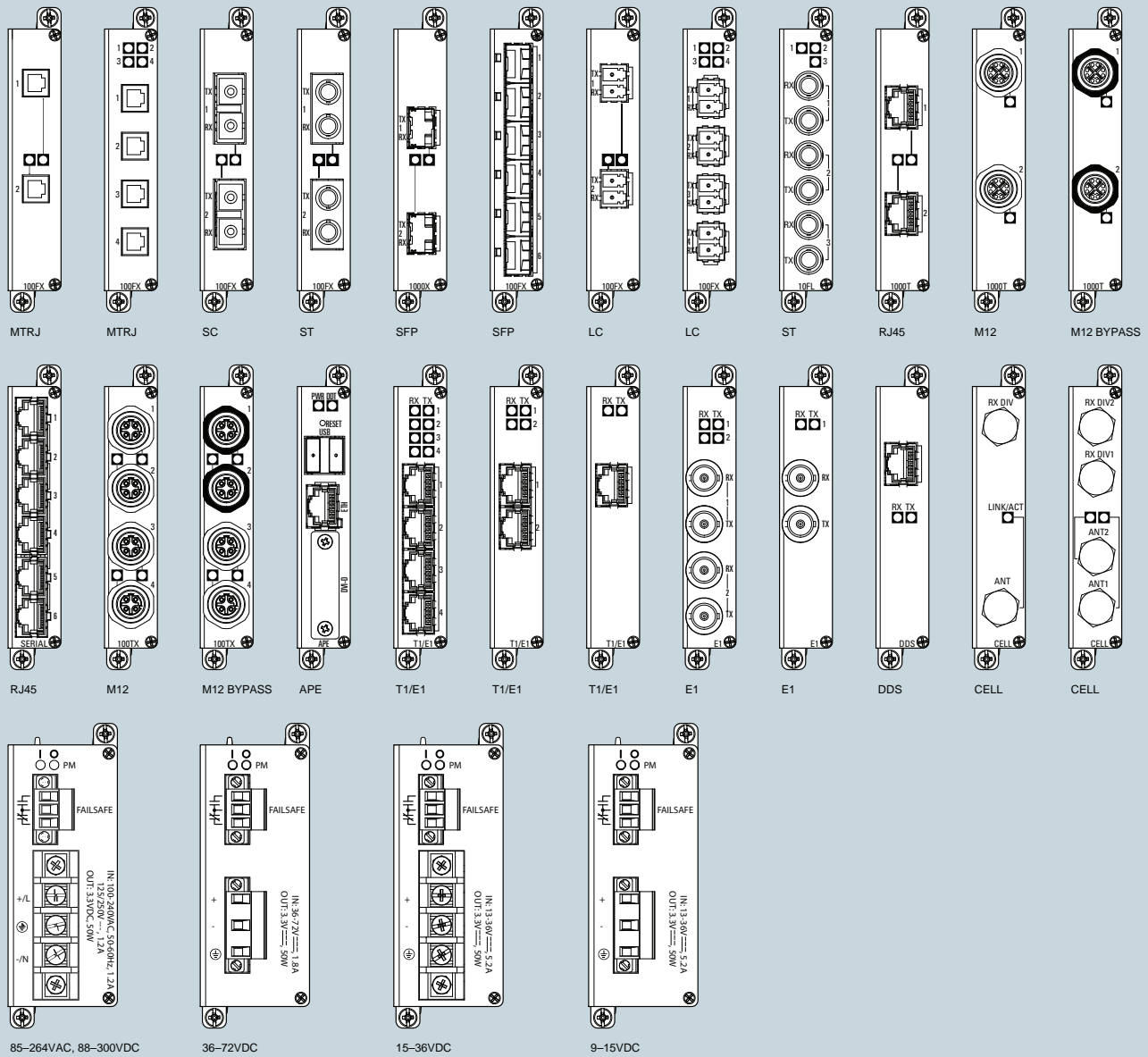

Hot-swappable RUGGEDCOM RX5000 modules

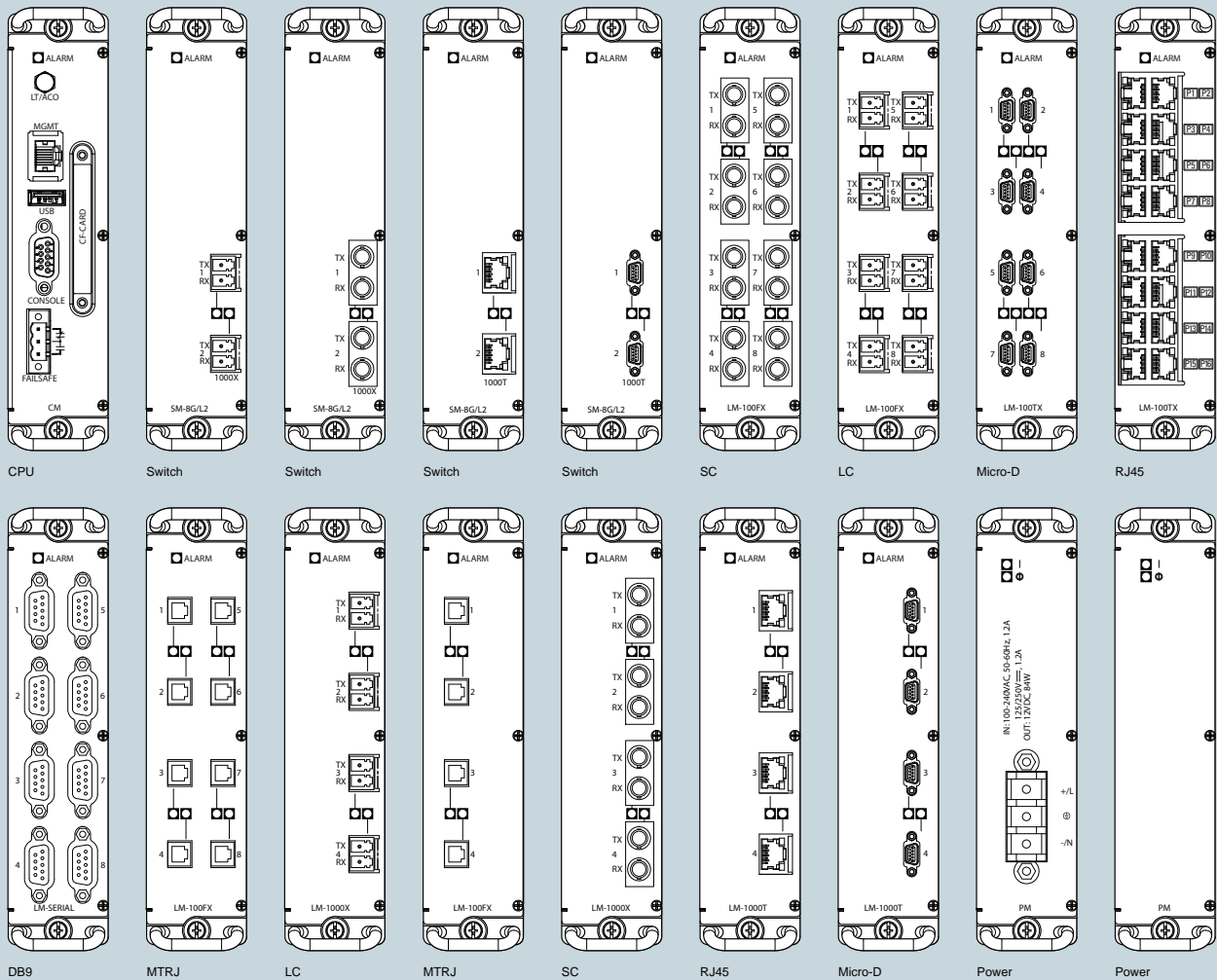

Modules

Feature key mapping

Feature keys are upgradeable by purchasing an upgrade package. Upgrading switching hardware requires replacement of the chassis (RUGGEDCOM RX15xx) or control module (RUGGEDCOM RX5000 / RUGGEDCOM MX5000).

Features required	Switching hardware required	Feature key to order
L2 Switching, VLAN, QoS, MSTP, RSTP, eRSTP, SNTP, L2TP, Port Rate Limiting, Broadcast Storm Filtering, Port Mirroring, SNMP, RMON, CLI, Web UI, Hot-Swap, USB main storage, Serial	Layer 2	L2SE
All L2SE features, as well as: L3 Switching, DHCP, VRRP, PIM, OSPF, BGP, IS-IS, RIP, T1/E1, Cell, DDS, Traffic Prioritization, Firewall, MPLS, IS-IS, Brute Force Attack prevention	Layer 2	L3SEL2HW
	Layer 3	L3SEL3HW
All L3SE features, as well as: IPSec, VPN, dead peer detection	Layer 2	L3SECL2HW
	Layer 3	L3SECL3HW

Mechanical characteristics

	RUGGEDCOM RX1500	RUGGEDCOM RX1501	RUGGEDCOM RX1510	RUGGEDCOM RX1511	RUGGEDCOM RX1512	RUGGEDCOM RX5000	RUGGEDCOM MX5000
Ingress Protection	IP 40						
Maximum weight	5 kg			3.5 kg	2.5 kg	16 kg	
Width	440 mm (19")		240 mm	155 mm	115 mm	440 mm (19")	
Depth	300 mm		200 mm			220 mm	
Height	44 mm (1U)		125 mm (3 U)			176 mm (4U)	
Maximum Heat Dissipation	65 W 222 BTU/hr			35 W 120 BTU/hr	30 W 102 BTU/hr	110 W 375 BTU/hr	



RUGGEDCOM APE line module

Utility grade processing platform for critical applications

Orderable as a line module for the RUGGEDCOM RX1500 product family

- Windows 7 embedded
- CheckPoint GAIa
- Debian Linux

2 physically separated Gigabit Ethernet interfaces for:

- Industrial
- IPsec/VPN site links
- IDS (requires Services contract)
- Secure access (RUGGEDCOM CROSSBOW)
- Protocol conversion (RUGGEDCOM ELAN)
- Customer applications

Integrated applications

Secure Remote Access

RUGGEDCOM CROSSBOW SAC can be installed internally on RUGGEDCOM RX15xx, or on RUGGEDCOM APE.

Installation is possible at the time of order or in the field.

Protocol conversion

RUGGEDCOM ELAN can be installed on RUGGEDCOM RX15xx or on RUGGEDCOM APE

- Performance limits apply to internal RUGGEDCOM ELAN installation
- Internal RUGGEDCOM ELAN installation must be ordered at the same time as the RUGGEDCOM RX1500 unit
- RUGGEDCOM ELAN installation in field is not possible without special procedures

Security appliance

RUGGEDCOM APE can be ordered with CheckPoint GAIa for existing CheckPoint customers.

RUGGEDCOM APE with Linux can be bundled with RUGGEDCOM Services contracts for:

- Physical firewall (Shorewall configuration)
- Intrusion Detection Sensor (Snort) and Intrusion Detection System with rules selection

	RUGGEDCOM APE1402	RUGGEDCOM APE1404	RUGGEDCOM APE1402W7	RUGGEDCOM APE1404W7	RUGGEDCOM APE1404CKP
Front Ethernet	Gigabit, RJ45 port				
Backplane Ethernet	Gigabit, internal to RUGGEDCOM RX15xx chassis				
USB	2 ports, USB 2.0				
Processor	Intel Atom E660T, 32-bit, 5000 MIPS at 1.3 GHz, 512 KB cache, Intel HT and VT-x				
Display	DVI port				
RAM	2 GB DDR-2 industrial-grade PCB-soldered				
Operating system	Debian Linux		Windows 7 embedded		CheckPoint GAIa
SDD (fixed)	8 GB	16 GB	8 GB	16 GB	16 GB

Order options

RUGGEDCOM RX15xx order options	
Pluggable or screw terminal power modules	
01	12 VDC (9 – 15 VDC)
02	24 VDC (15 – 36 VDC)
03	48 VDC (36 – 72 VDC)
04	88 – 300 VDC or 85 – 264 VAC
Fixed power supply (RUGGEDCOM RX1512 only)	
05	11 – 72 VDC screw terminal block
Switch hardware	
06	Layer 2 switch
07	Layer 3 switch
Manufacturing modification	
08	Standard
09	Conformal coated
Mounting	
10	DIN and panel mount kit
11	19" rack mount kit
Software	
12	Layer 2 standard edition
13	Layer 3 standard edition
14	Layer 3 security edition
Application Processing Engine	
15	1.3 GHz, 2 GB RAM, 8 GB SATA, DVI-D video, 2 x USB, Linux
16	1.3 GHz, 2 GB RAM, 8 GB SATA, DVI-D video, 2 x USB, Windows 7 embedded
17	1.3 GHz, 2 GB RAM, 16 GB SATA, DVI-D video, 2 x USB, Linux
18	1.3 GHz, 2 GB RAM, 16 GB SATA, DVI-D video, 2 x USB, Windows 7 embedded
19	1.3 GHz, 2 GB RAM, 16 GB SATA, DVI-D video, 2 x USB, Checkpoint (Requires existing Checkpoint license)
100 BaseFX modules with 2-port modules	
20	2 x 100 FX – multimode, 1300 nm, ST connectors, 2 km
21	2 x 100 FX – multimode, 1300 nm, SC connectors, 2 km
22	2 x 100 FX – multimode, 1300 nm, LC connectors, 2 km
23	2 x 100 FX – multimode, 1300 nm, MTRJ connectors, 2 km
24	2 x 100 FX – singlemode, 1300 nm, ST connectors, 20 km
25	2 x 100 FX – singlemode, 1300 nm, SC connectors, 20 km
26	2 x 100 FX – singlemode, 1300 nm, LC connectors, 20 km
27	2 x 100 FX – singlemode, 1300 nm, SC connectors, 50 km
28	2 x 100 FX – singlemode, 1300 nm, LC connectors, 50 km
29	2 x 100 FX – singlemode, 1300 nm, SC connectors, 90 km
30	2 x 100 FX – singlemode, 1300 nm, LC connectors, 90 km

RUGGEDCOM RX15xx order options	
10 BaseFL / 100 BaseSX with 3-port modules	
31	3 x 10 FL / 100 SX – multimode, 850 nm, ST connectors, 2 km
100 BaseFX with 4-port modules	
32	4 x 100 FX – multimode, 1300 nm, LC connectors, 2 km
33	4 x 100 FX – multimode, 1300 nm, MTRJ connectors, 2 km
34	4 x 100 FX – singlemode, 1300 nm, LC connectors, 50 km
35	4 x 100 FX – singlemode, 1300 nm, LC connectors, 90 km
36	4 x 100 FX – SFP
Gigabit Ethernet with 2-port modules	
37	2 x 1000 SX – multimode, 850 nm, LC connectors, 500 m
38	2 x 1000 LX – singlemode, 1300 nm, SC connectors, 10 km
39	2 x 1000 LX – singlemode, 1300 nm, LC connectors, 10 km
40	2 x 1000 LX – singlemode, 1300 nm, SC connectors, 25 km
41	2 x 1000 LX – singlemode, 1300 nm, LC connectors, 25 km
42	2 x 1000 LX – SFP
WAN port options	
43	1 x T1/E1 RJ48 (channelized/unchannelized)
44	2 x T1/E1 RJ48 (channelized/unchannelized)
45	4 x T1/E1 RJ48 (channelized/unchannelized)
46	1 x E1 75 Ohms BNC (channelized/unchannelized)
47	2 x E1 75 Ohms BNC (channelized/unchannelized)
48	1 x GSM/EDGE/HSPA
49	2 x GSM/EDGE/HSPA
50	1 x EVDO rev A Verizon US
51	2 x EVDO rev A Verizon US
52	2 x GSM/EDGE/HSPA and EVDO rev A Verizon US
53	1k DDS RJ48 (56k Master/Slave 64k Slave)
M12 copper Ethernet modules	
54	2 x 10/100/1000 TX – 8-pin, X-coded
55	2 x 10/100/1000 TX – 8-pin, X-coded with controlled bypass
56	2 x 10/100/1000 TX – 8-pin
57	2 x 10/100/1000 TX – 8-pin, A-coded with controlled bypass
58	4 x 10/100 TX – 4-pin, D-coded
59	4 x 10/100 TX – 4-pin, D-coded with controlled bypass
60	4 x 10/100 TX – 8-pin
61	4 x 10/100 TX – 8-pin, A-coded with controlled bypass
Copper Ethernet modules	
62	6 x 10/100 TX – RJ45
63	2 x 10/100/1000 TX – RJ45
Serial line module	
64	6 x RS232/RS422/RS485 – RJ45

RUGGEDCOM RX5000 and RUGGEDCOM MX5000 order options	
Power modules	
01	88 – 300 VDC or 85 – 264 VAC screw terminal block on module
02	88 – 300 VDC or 85 – 264 VAC terminal block on front
Ethernet and power indicators	
03	Rack front mount, interfaces and LEDs on front
04	Rack rear mount, no interfaces/LEDs on front panel
05	Rack rear mount, front panel with power terminal blocks
Manufacturing modifications	
06	Standard
07	Conformal coated
Mounting	
08	Panel mount kit
09	19" Rack mount kit
Layer 2 8 gigabit throughput switch modules	
10	2 x 1000 LX – singlemode, 1310 nm, SC connectors, 10 km
11	2 x 1000 LX – singlemode, 1310 nm, LC connectors, 10 km
12	2 x 1000 LX – singlemode, 1310 nm, SC connectors, 25 km
13	2 x 1000 LX – singlemode, 1310 nm, LC connectors, 25 km
14	2 x 1000 LX – SFP
Layer 3 8 gigabit throughput switch modules	
15	2 x 10/100/1000T – RJ45
16	2 x 1000 SX – multimode, 850 nm, LC connectors, 500 m
17	2 x 1000 LX – singlemode, 1310 nm, SC connectors, 10 km
18	2 x 1000 LX – singlemode, 1310 nm, LC connectors, 10 km
19	2 x 1000 LX – singlemode, 1310 nm, SC connectors, 25 km
20	2 x 1000 LX – singlemode, 1310 nm, LC connectors, 25 km
21	2 x 1000 LX – SFP
Layer 3 88 gigabit switch module	
22	2 x 10G SFP+ (empty slot)
Software	
26	Layer 2 standard edition
27	Layer 3 standard edition
29	Layer 3 security edition
10/100Base TX with 16-port modules	
34	16 x 10/100TX – RJ45

RUGGEDCOM RX5000 and RUGGEDCOM MX5000 order options	
100BaseFX with 8-port modules	
35	8 x 100 FX – multimode, 1310 nm, ST connectors, 2 km
36	8 x 100 FX – multimode, 1310 nm, SC connectors, 2 km
37	8 x 100 FX – multimode, 1310 nm, LC connectors, 2 km
38	8 x 100 FX – multimode, 1310 nm, MTRJ connectors, 2 km
39	8 x 100 FX – singlemode, 1310 nm, ST connectors, 20 km
40	8 x 100 FX – singlemode, 1310 nm, SC connectors, 20 km
41	8 x 100 FX – singlemode, 1310 nm, LC connectors, 20 km
42	8 x 100 FX – singlemode, 1310 nm, SC connectors, 50 km
43	8 x 100 FX – singlemode, 1310 nm, LC connectors, 50 km
44	8 x 100 FX – singlemode, 1310 nm, SC connectors, 90 km
45	8 x 100 FX – singlemode, 1310 nm, LC connectors, 90 km
100BaseFX with 4-port modules	
46	4 x 100 FX – multimode, 1310 nm, ST connectors, 2 km
47	4 x 100 FX – multimode, 1310 nm, SC connectors, 2 km
48	4 x 100 FX – multimode, 1310 nm, LC connectors, 2 km
49	4 x 100 FX – multimode, 1310 nm, MTRJ connectors, 2 km
50	4 x 100 FX – singlemode, 1310 nm, ST connectors, 20 km
51	4 x 100 FX – singlemode, 1310 nm, SC connectors, 20 km
52	4 x 100 FX – singlemode, 1310 nm, LC connectors, 20 km
53	4 x 100 FX – singlemode, 1310 nm, SC connectors, 50 km
54	4 x 100 FX – singlemode, 1310 nm, LC connectors, 50 km
55	4 x 100 FX – singlemode, 1310nm, SC connectors, 90 km
56	4 x 100 FX – singlemode, 1310 nm, LC connectors, 90 km
Gigabit Ethernet with 4-port modules	
57	4 x 10/100/1000 TX RJ45
58	4 x 1000 SX – multimode, 850 nm, LC connectors, 500 m
59	4 x 1000 LX – singlemode, 1310 nm, SC connectors, 10 km
60	4 x 1000 LX – singlemode, 1310 nm, LC connectors, 10 km
61	4 x 1000 LX – singlemode, 1310 nm, SC connectors, 25 km
62	4 x 1000 LX – singlemode, 1310 nm, LC connectors, 25 km
63	4 x 1000 LX – SFP blank (no transceivers)
Serial line module	
64	8 x RS232/RS422/RS485 configurable DB9